



Eastern
**CHAIN LINK
FENCE**

**CHAIN LINK FENCE / FITTINGS /
SPECIALIZED FENCE**

04/24/23

SALES TERMS AND CONDITIONS



FREIGHT/DELIVERY

All deliveries within our delivery territory will be made FREE of charge unless the nature of the delivery is unusual due to special handling and for timing requirements.

Unless prior arrangements have been made, we require the customer's presence and assistance with receiving our delivery.

RETURN POLICY

Any customer returning material must first contact Eastern for a return authorization within five days. **No returns on wood or vinyl products.** Any returns shipped without authorization will not be accepted. Eastern requires the returned goods to be properly packaged and in the same condition as was originally received. Eastern reserves the right to inspection on returned products prior to approving the final credit memo.

A minimum restocking charge of 20% (minimum \$35.00) will be charged on all material returned unless the return results from our error.

SPECIAL ORDERS

Eastern prefers to receive a written purchase order when a special or non-stock item is being purchased. However, as a convenience to our customers, we will accept verbal orders. We may require a non-refundable 50% deposit or advance payment depending upon the nature of the order. Once ordered, there can be no cancellation or return on special orders.

QUOTATIONS, SPECIFICATIONS & CERTIFICATIONS

Quotations will be given based upon the customer's breakdown of the material requirements. Eastern will gladly assist in helping you with the quoting of material, however, we are not responsible for products ordered incorrectly.

When material being purchased is required to meet certain specifications and/or certifications will be required, we must be notified at the time the order is being placed.

CATALOG CHANGES

As you will notice, this catalog is very comprehensive and even though we go to extreme efforts to keep it updated it would be impossible to update it for every change that may occur. Therefore, product information and prices shown are subject to change without notice. We are also not responsible for typographical errors.

TRADEMARK REPRODUCTION RIGHTS

Eastern Wholesale Fence LLC ©2023 All Rights Reserved. Eastern, the Eastern Logo, Illusions, Illusions Vinyl Railing System, Grand Illusions Color Spectrum, Grand Illusions Vinyl WoodBond, Pen Pals, Ornamental Aluminum, System 21, Uni-Weld, Eastern White Cedar, EverStrong, Internal Slide Gate, Investment Grade and Marine Link logos are all trademarks of Eastern Wholesale Fence LLC, registered in the U.S. and other countries. No part of this publication may be reproduced, stored in a retrieval system or transmitted in any form or by any means, electronic, mechanical, photocopying, recording, scanning or otherwise, except as permitted under Sections 107 or 108 of the 1976 United States Copyright Act, without the prior written permission of Eastern Wholesale Fence LLC



Eastern Wholesale Fence LLC • 1-800-339-3362

266 Middle Island Rd. Medford, NY 11763 • www.easternfence.com

EASTERN CHAIN LINK 04/24/23 | Eastern Wholesale Fence LLC ©2023 | All Rights Reserved

TABLE OF CONTENTS

INFORMATION

Sales Terms and Conditions	B-2
Table of Contents	B-3
Why Eastern Chain Link & Specialized Fence?	B-4
Ordering Checklist.....	B-6
Chain-Link Information Pages	B-8
Chain-Link Fence Installation Instructions.....	B-10

SYSTEM 21 COLOR VINYL CHAIN LINK PRODUCTS

System 21 Vinyl Coated Chain Link Fabric	B-14
System 21 Color Pipe	B-15
System 21 Color Chain-Link Fittings.....	B-18
System 21 Gate Frames and Gates	B-22



EASTERN CHAIN-LINK FENCE GALVANIZED PRODUCTS

Galvanized Chain-Link Fabric.....	B-25
Galvanized Pipe.....	B-26
Galvanized Chain-Link Fittings.....	B-32
Post Caps, Plugs	B-32
Tops, and Sleeves.....	B-33
Tension Bands and Brace Bands.....	B-34
Clamps	B-35
Rail Ends and Bolts.....	B-36
Fence Ties and Fabric Anchors	B-37
Post Hinges and Frame Hinges	B-38
Oarlocks and Drop Fork Brackets	B-39
Latches and Closers	B-40
Closers, Residential Locking Device, Drop Rods, Scrolls.....	B-41
Gate Clips, Gate Corners, Center Stops, Hold Back.....	B-42
Industrial Hinges, Swing Gate Wheels, Industrial Locking Devices	B-43
Tension Bars, Truss Rods, Hog Rings.....	B-44
Barb Wire, Barb Arms.....	B-45
Barb Arm Blade, Barb Arm Bases, Barb Arms, CEMENT	B-46
Fulcrum Latches, Hi Security Latch, Cantilever Latch,	B-47
Cantilever Rollers, Cantilever Roller Guards	
Miscellaneous	
Coil Spring Wire, Galvanized Chain,	B-48
Baseball Backstop Adaptor, Floor Flanges	
Overhead Slide Gate Systems.....	B-49
Razor Ribbon	B-51
Speed Rail Fittings (Aluminum)	B-52
Speed Rail Fittings (Galvanized).....	B-53
Rolling Gate Kits	B-55
Rolling Gate Hardware	B-56
Galvanized Gate Frames	B-57
Barrier Gates.....	B-60
Pen Pals Kennel Enclosures.....	B-61
Internal Slide Gates	B-62
Cantilever Slide Gates.....	B-66
Rolling Gate Frames.....	B-68
Specialty Fabrication	B-69
Decorative Slats and Hedge	B-70
Guard Rail	B-71



SPECIALIZED FENCE PRODUCTS B-76

Snow Fence, Orange Safety Fence, Farm and Field Fence, Studded T-Post.....	B-77
Vinyl Coated Welded Mesh, Pool Fence, Heavy Duty U-Posts, Staples	B-78
Deer Fence	B-79
Steel Hex Web Deer Fence.....	B-80
Temp Fence	B-81
Privacy Screens	B-83

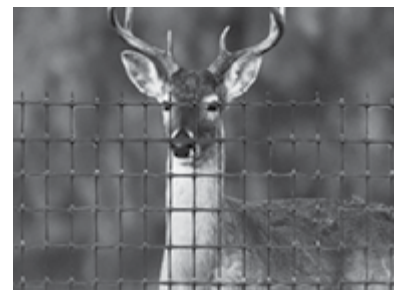

Why Eastern Chain Link & Specialized Fence?



Eastern Chain Link Fence

Eastern Fence has the largest pipe & chain link fence inventory in the Northeast! We carry a complete line of chain link pipe products including every residential or commercial application you could imagine. We supply it all.

INCLUDING: GALV, SCHEDULE 40, 8-5/8" PIPE (Industry Leader), ALL SS PRODUCTS, FABRIC, PIPE & TUBE, FITTINGS, GATES & KENNELS, SPECIALTY FENCE

IN STOCK AND AVAILABLE FOR NEXT DAY DELIVERY



System21™

System 21 vinyl coated color chain link fence system is available in your choice of green, black, and brown. Our exclusive coating process bonds a tough resilient protective layer of polyester powder coating over extra heavy gauge pipe, gates, fittings and wire, giving the entire system an attractive finish with an extended durability that will last for many years.



Eastern Temporary Fence & Privacy Screens

Eastern Temporary Fence Panels are perfect for construction sites, domestic housing sites, sporting events, special events, concerts, crowd control, and a wide range of industrial and engineering applications. Eastern Temporary Fence is modular fence designed to meet or exceed industry standards. Eastern Temporary Fence panels (ETF) are easy to install and tear down. They are freestanding, easy and safe to assemble, and reusable.



Pen Pals™

PenPals™ portable pet runs are made of high quality welded construction and have a galvanized steel framework. They have a smooth finish galvanized fabric, are portable and free standing, have an easy 1, 2, 3 installation and a limited warranty.



Eastern Hedge and Privacy Slats

Eastern Fence Chain Link Fence Slats are extruded from High Density Polyethylene (HDPE), color pigments and ultra violet (UV) inhibitors, specifically designed to inhibit the harmful effects of sunlight and lengthen the life of the product. The only exceptions are Winged Slats which also include Ethyl Vinyl Acetate (EVA), which is a softer plastic to keep wings flexible and resilient. Eastern Fence Products are resistant to: severe weather conditions, salt water, sand, road dirt, most acids, alcohol, alkaline, ammonia, petroleum distillates, and common environmental pollutants.

ORDERING CHECKLIST

Please Have Your Material List Ready To Go When You Call

Being that Eastern Chain Link Fence products are sold wholesale to the trade, it is highly suggested that you have a material list for your order prior to calling. Please feel free to use this checklist and the "CHAIN LINK ORDERING SHEET" as a guide prior to your call.

Wire

Also known industry wide as the fabric of the chain link fence. This is the finishing touch to complete your chain link fence.

Gates

Don't forget your gates! Walk gates, drive gates, rolling gates, cantilever gates, overhead gates, barrier gates, and internal slide gates. Residential or Industrial. (NOTE: Remember for each Eastern Chain Link Fence gate opening, you should order wider diameter and heavier gauged posts.)

Posts & Rails

When ordering your posts, you should check the post spacing chart in the Eastern Chain Link Fence Installation Instructions. This will help you in knowing the length and spacing required for your fence installation. Gate posts are usually bigger than terminal posts. Line posts are your unity during a run of chain link fence. Top, middle, or bottom rails are also an important part of your fence installation, but not always necessary. It depends on the job requirements and/or specifications.

Post Caps

Terminal post caps, line tops, and gate caps are all a necessity when installing your Eastern Chain Link Fence.

Hardware & Fittings

- Hinges - Pressed steel or malleable, residential or commercial
- Latches (oarlocks, self-latching auto latches, Magna-Latches, and industrial locking devices)
- Drop rods and guides (Residential and Commercial)
- Spring closers (Sold separately for posts up to 2-1/2". Modifications can be made to retro fit other size posts.)
- Tension bands, brace bands, rail ends, tension bars, fence ties, boulevard and end-clamps, coil wire, nuts and bolts and more...

Order Process

Orders may be submitted by calling (631)-698-0900 or (800)-339-3362, faxing to (631)-698-6408 or (800)-788-0411, or e-mailing to sales@easternfence.com.

RESI CHAIN LINK FENCE PARTS

STANDARD RESI C/L PARTS

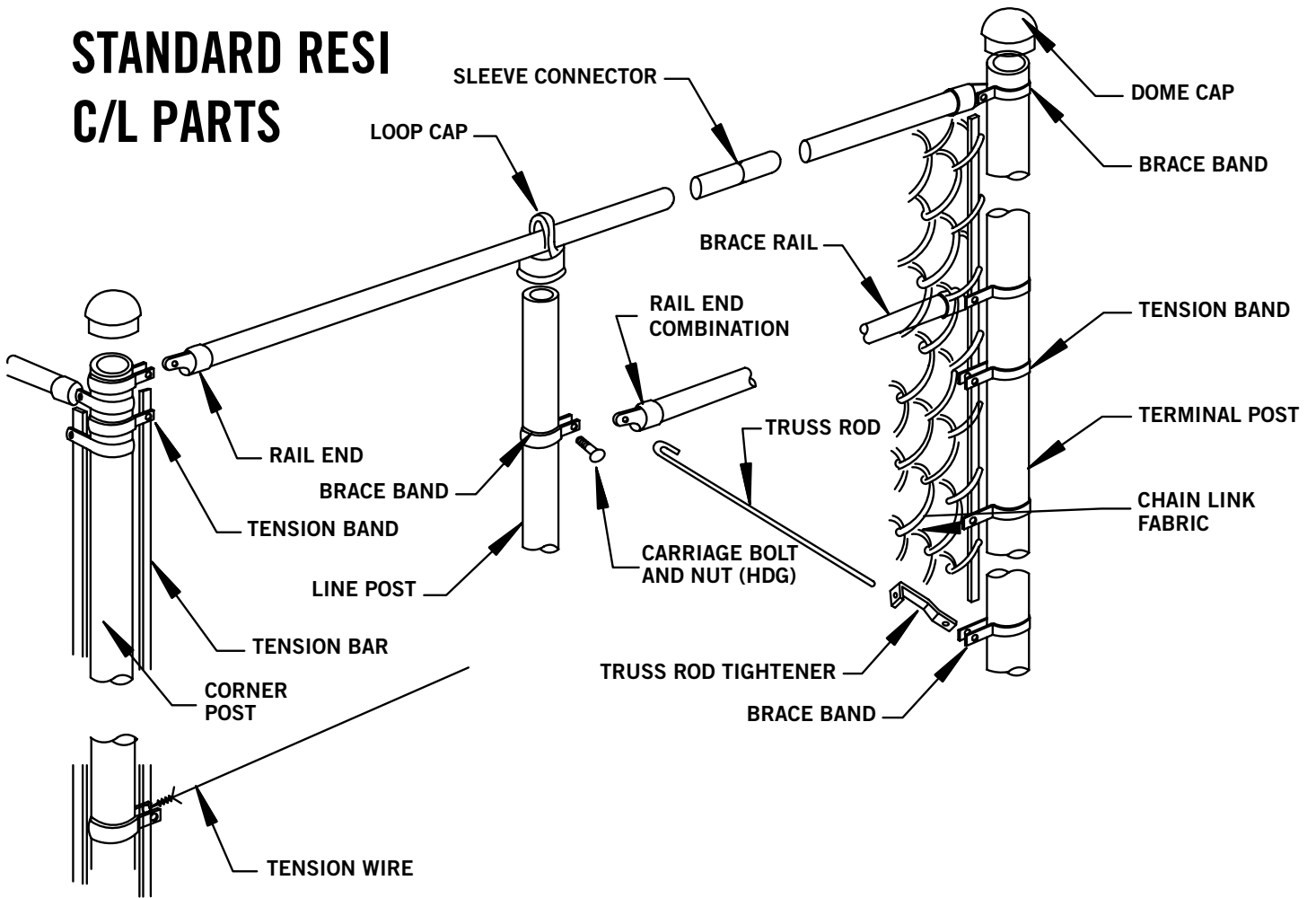

TYPICAL RESIDENTIAL CHAIN LINK FENCE INSTALLATION

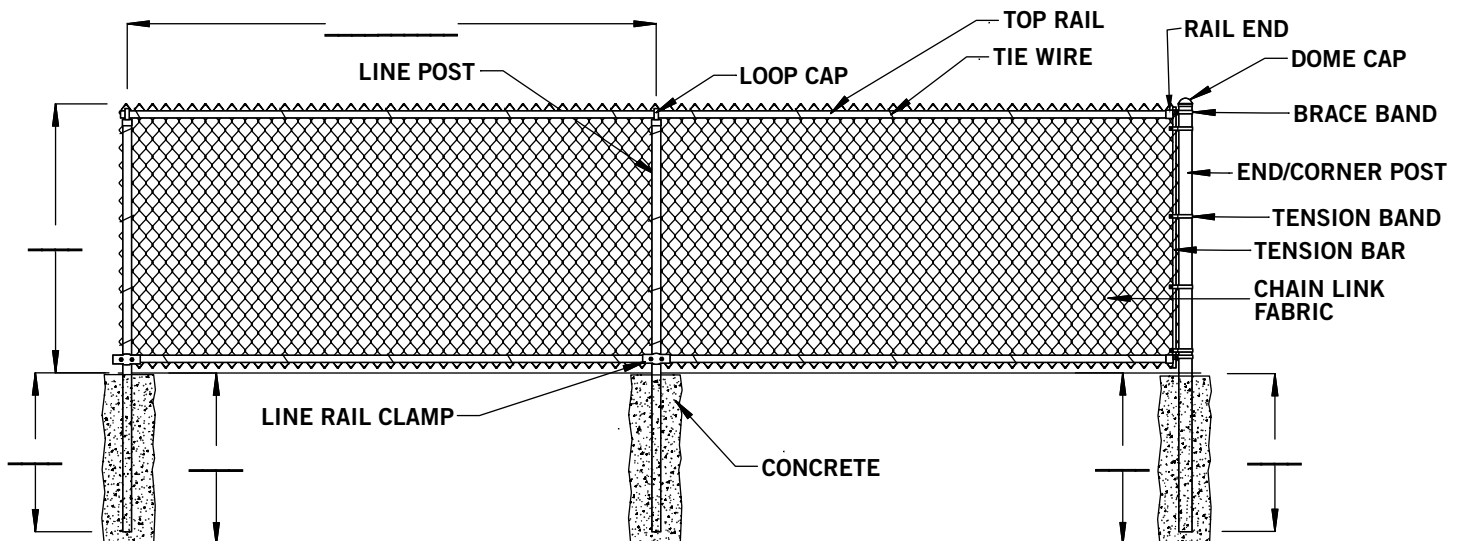

COMMERCIAL C/L PARTS

TYPICAL COMMERCIAL CHAIN LINK FENCE INSTALLATIONS

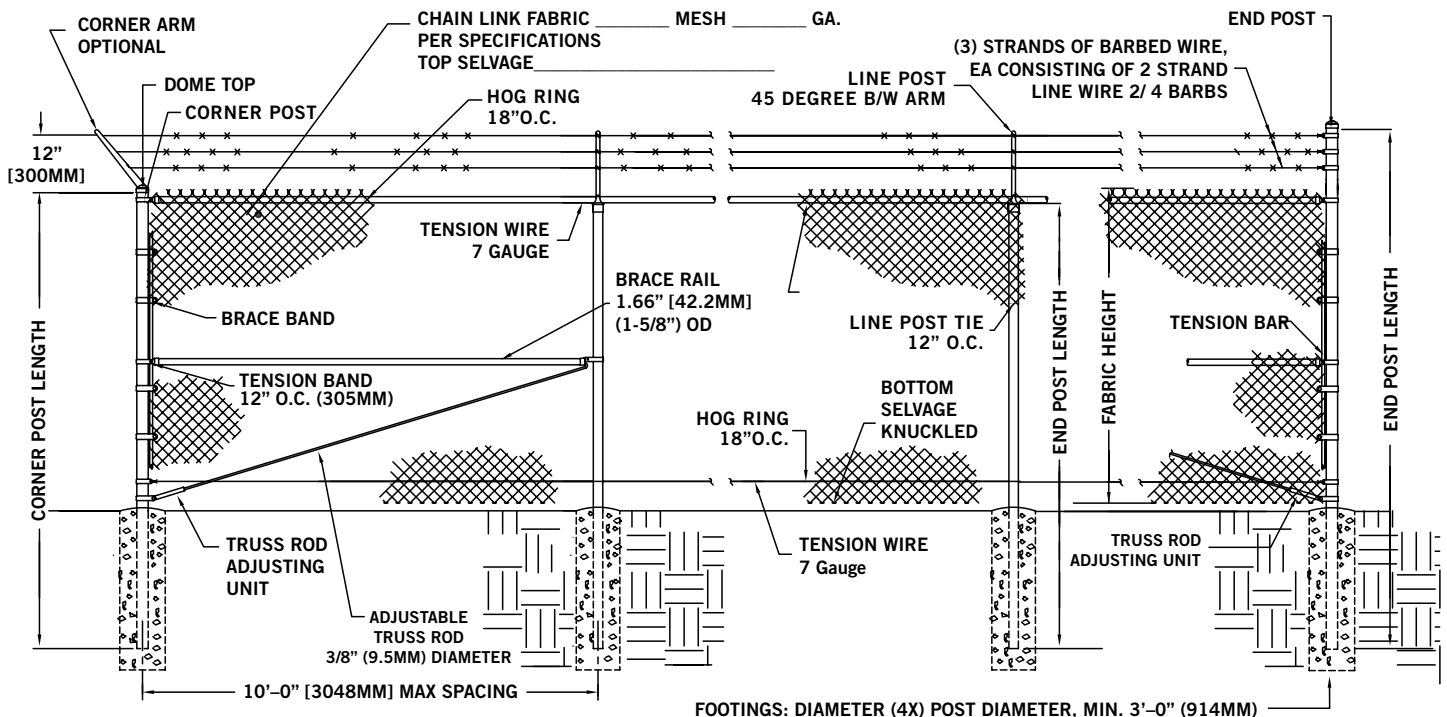
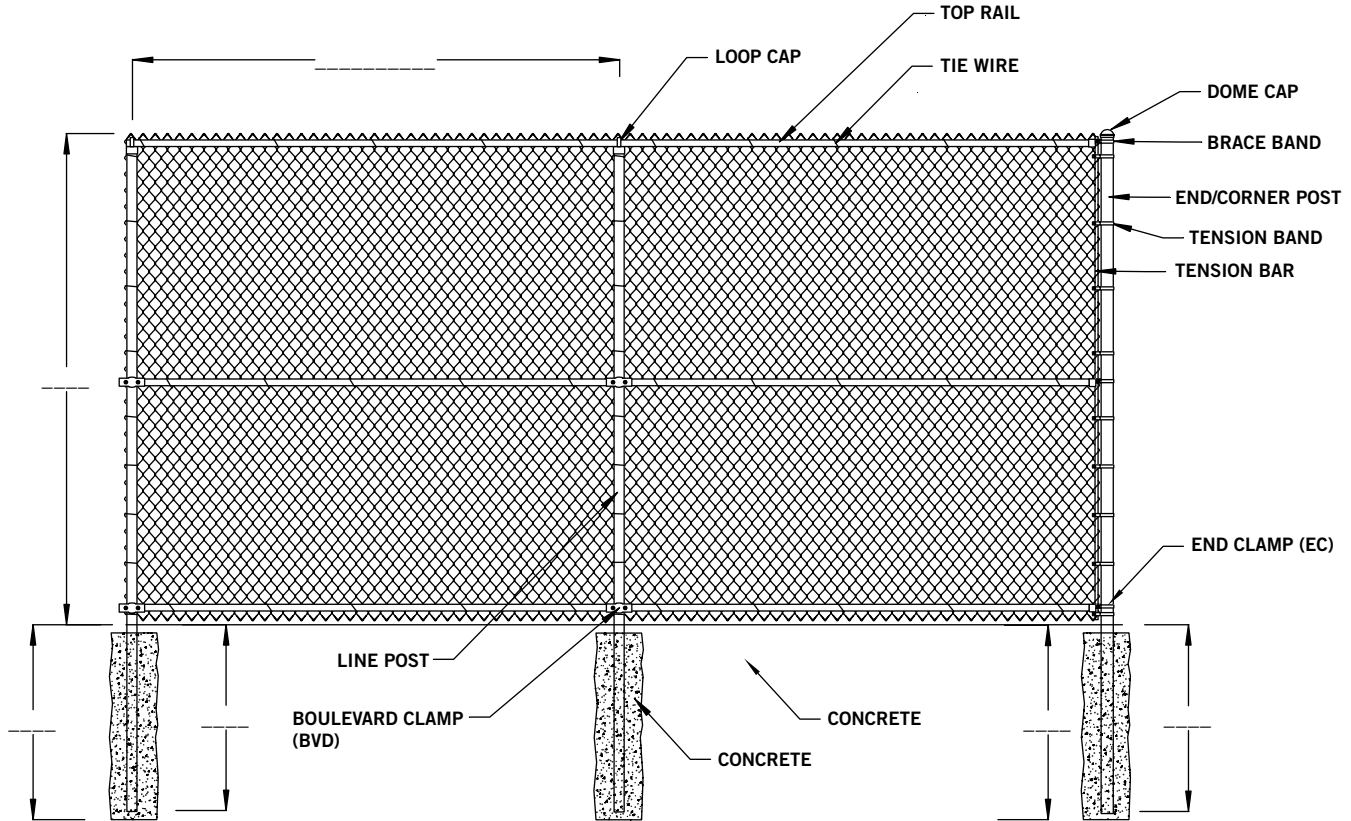



**CHAIN LINK FENCE
MANUFACTURERS INSTITUTE**

*Eastern
Fence®*

**STEP • BY • STEP
METHOD
FOR INSTALLING
YOUR OWN**

CHAIN LINK FENCE

**HOMES
YARDS
SWIMMING POOLS**

HINTS FOR ERECTING CHAIN LINK FENCE

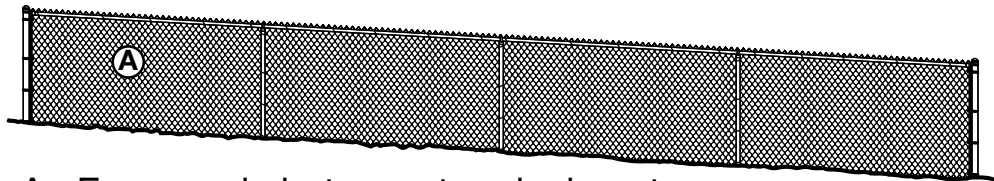

A Even grade between terminal posts

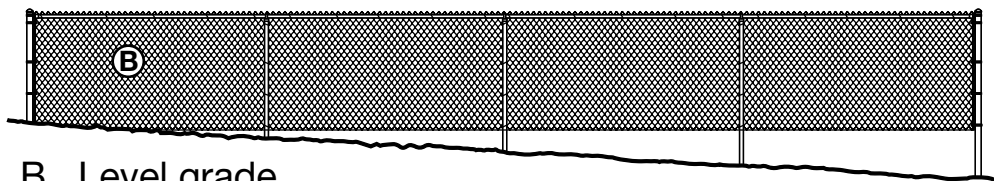

B Level grade

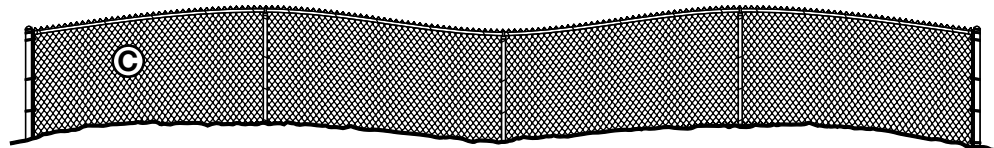

C Fence following grade

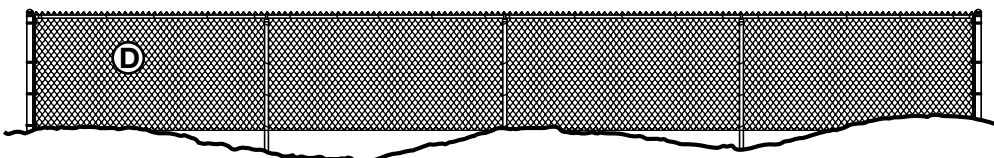

D Level grade with rolling terrain

HOW TO ERECT CHAIN LINK FENCE

STEP 1 - SURVEY PROPERTY LINES

Be sure that the desired location of fence lines do not exceed property lines. This is very important. We recommend that all posts be set approximately 4" inside of the property line to avoid encroaching on adjoining property with the concrete foundations. This may be done by stretching string or chalk lines on the property line and setting posts approximately 4" inside of them.

STEP 2 - LOCATE AND SET TERMINAL POSTS

First determine the location of end, corner, and gate posts (which are referred to as terminal posts).

Distance between gate posts is determined by adding the actual width of the gate to an allowance for hinges and latches. Single walk gates require 3¾" for hinges and latches and double drive gates require 5½". For example, a 3 foot walk gate should measure 32¼" wide. Adding 3¾" to the width means that the distance between posts (inside face to inside face) should be 36". (See Figure 13.)

Now, dig the holes as shown below in Figure 1. (To determine depth of hole see Figure 2 - Measurement C.)

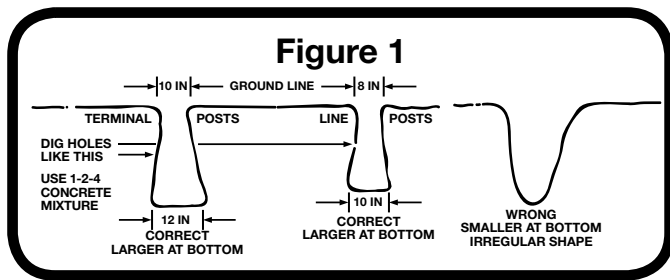

Next, mark all posts with crayon or chalk for the correct height of fence you are installing (see Figure 2 →). Terminal posts should be set 2" higher than the width of the fabric and line posts 2" lower than the fabric width.

Set the terminal posts in concrete using a concrete mix as follows: 1 part cement, 2 parts sand, and 4 parts gravel. Mix a fairly heavy solution as too much water weakens concrete and may cause cracking. Use a carpenter's level to set posts plumb. Crown all post footings for water drainage by sloping concrete away from post.

WARNING: WHEN DIGGING POST HOLES WATCH FOR AND CHECK OUT ANY UNDERGROUND CABLE OR PIPE LINES AND CONTACT YOUR LOCAL UTILITY.

STEP 3 - LOCATE AND SET LINE POSTS

Mark the grade line on all line posts measuring from the top down as shown in Figure 2. Then measure the distance between terminal posts and check line post spacing chart (Figure 3 below) for exact distance to allow between line posts.

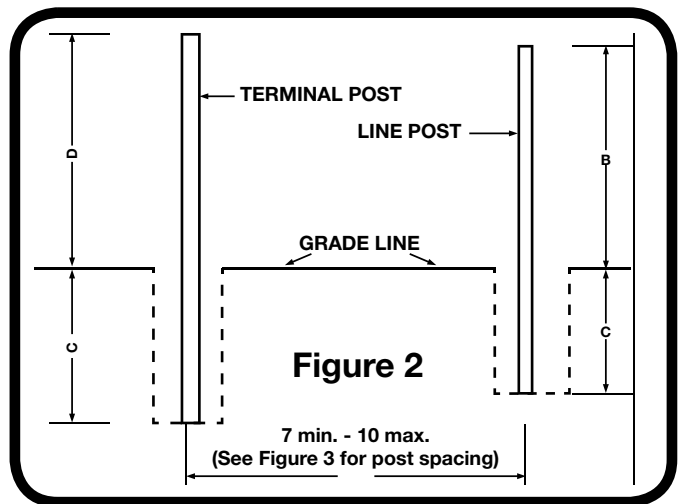

*MEASUREMENT C - Depth that post will be in the ground will be determined by lengths of posts being used, after A or B dimension is subtracted from overall length of posts.

Fence Height	A	B	C
3' 6"	44"	40"	*
4' 0"	50"	46"	*

Line Post Spacing Chart

Space	Set Post Apart	Space	Set Post Apart	Space	Set Post Apart	Space	Set Post Apart	Space	Set Post Apart
30 ft.	10 ft.	51 ft.	8 ft. 6 in.	71 ft.	8 ft. 9 in.	92 ft.	9 ft. 2 in.	112 ft.	9 ft. 4 in.
31 ft.	7 ft. 9 in.	52 ft.	8 ft. 8 in.	72 ft.	9 ft.	93 ft.	9 ft. 3 in.	113 ft.	9 ft. 5 in.
32 ft.	8 ft.	53 ft.	8 ft. 10 in.	73 ft.	9 ft. 2 in.	94 ft.	9 ft. 5 in.	114 ft.	9 ft. 6 in.
33 ft.	8 ft. 3 in.	54 ft.	9 ft.	74 ft.	9 ft. 3 in.	95 ft.	9 ft. 6 in.	115 ft.	9 ft. 7 in.
34 ft.	8 ft. 6 in.	55 ft.	8 ft. 2 in.	75 ft.	9 ft. 4 in.	96 ft.	9 ft. 7 in.	116 ft.	9 ft. 8 in.
35 ft.	8 ft. 9 in.	56 ft.	9 ft. 4 in.	76 ft.	9 ft. 6 in.	97 ft.	9 ft. 7 in.	117 ft.	9 ft. 9 in.
36 ft.	9 ft.	57 ft.	9 ft. 6 in.	77 ft.	9 ft. 7 in.	98 ft.	9 ft. 8 in.	118 ft.	9 ft. 10 in.
37 ft.	9 ft. 3 in.	58 ft.	9 ft. 8 in.	78 ft.	9 ft. 9 in.	99 ft.	9 ft. 9 in.	119 ft.	9 ft. 10 in.
38 ft.	9 ft. 6 in.	59 ft.	9 ft. 10 in.	79 ft.	9 ft. 10 in.	100 ft.	10 ft.	120 ft.	10 ft.
40 ft.	10 ft.	60 ft.	10 ft.	80 ft.	10 ft.	101 ft.	9 ft. 2 in.	121 ft.	9 ft. 3 in.
41 ft.	8 ft. 2 in.	61 ft.	8 ft. 8 in.	81 ft.	9 ft.	102 ft.	9 ft. 3 in.	122 ft.	9 ft. 4 in.
42 ft.	8 ft. 5 in.	62 ft.	8 ft. 10 in.	82 ft.	9 ft. 1 in.	103 ft.	9 ft. 4 in.	123 ft.	9 ft. 5 in.
43 ft.	8 ft. 6 in.	63 ft.	9 ft.	83 ft.	9 ft. 3 in.	104 ft.	9 ft. 5 in.	124 ft.	9 ft. 6 in.
44 ft.	8 ft. 9 in.	64 ft.	9 ft.	84 ft.	9 ft. 4 in.	105 ft.	9 ft. 6 in.	125 ft.	9 ft. 7 in.
45 ft.	9 ft.	65 ft.	9 ft. 3 in.	85 ft.	9 ft. 6 in.	106 ft.	9 ft. 7 in.	126 ft.	9 ft. 8 in.
46 ft.	9 ft. 2 in.	66 ft.	9 ft. 5 in.	86 ft.	9 ft. 7 in.	107 ft.	9 ft. 8 in.	127 ft.	9 ft. 9 in.
47 ft.	9 ft. 5 in.	67 ft.	9 ft. 7 in.	87 ft.	9 ft. 8 in.	108 ft.	9 ft. 9 in.	128 ft.	9 ft. 10 in.
48 ft.	9 ft. 7 in.	68 ft.	9 ft. 8 in.	88 ft.	9 ft. 9 in.	109 ft.	9 ft. 10 in.	129 ft.	9 ft. 10 in.
49 ft.	9 ft. 9 in.	69 ft.	9 ft. 10 in.	89 ft.	9 ft. 10 in.	110 ft.	10 ft.		
50 ft.	10 ft.	70 ft.	10 ft.	91 ft.	9 ft. 2 in.	111 ft.	9 ft. 3 in.		

Next, stretch a masons line from outside of terminal posts to outside of terminal posts (be sure the concrete has set up sufficiently so as not to lose plumb). The line post holes should be lined up so that when they are set in the center of their holes, their centers will line up with the terminal post centers. This means the outside faces of the line posts will be about 1/4" inside of the line stretched between the outside of the terminal posts. Now dig the line post holes and set the line posts.

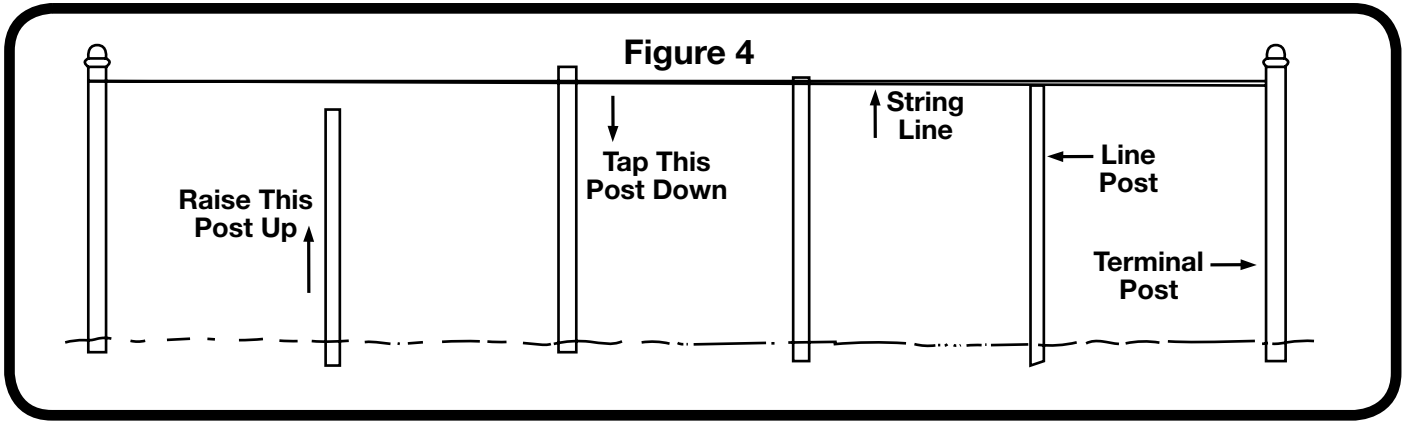

Next, stretch your masons line taut four inches below terminal post tops and use as a guide to align height of line posts (see Figure 4 above). If necessary to adjust height of any post either up or down, simply raise or lower post as illustrated before concrete sets up. Use your level to keep plumb while adjusting post height.

STEP 4 - APPLY FITTINGS TO TERMINAL POSTS

Check material list and fittings identification chart. After the posts have been installed and the concrete allowed to set, slip tension and brace bands on terminal posts. (See Figure 5.) The tension bands should be spaced approximately 10-12" apart. Do not spread or distort bands. All bolt heads for bands are on the outside of fence and the threaded ends are on the inside. Then apply all terminal post caps.

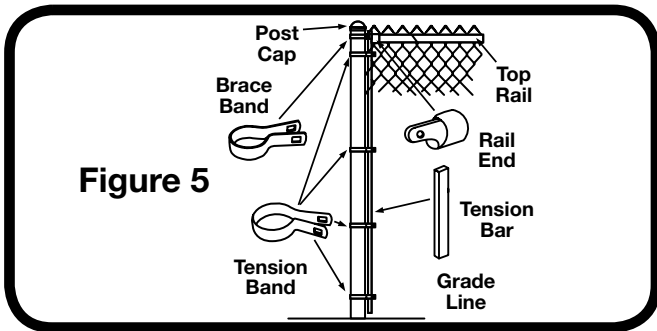

STEP 5 - APPLY TOP RAIL

Next, attach loop caps. (See Figure 6.) They are set with the top rail hole offset toward the outside of the fence making flush the outside face of the top rail through the loop caps. (See Figure 7.) Join the top rail with swaged end where required. (See Figure 8.) End of the top rail fits into rail end fittings on the terminal post. (See Figure 9.)

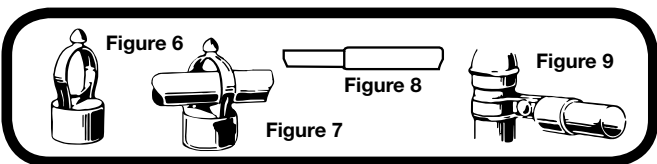

STEP 6 - HANG FABRIC

After assembling the framework, unroll the fabric on the ground along the fence line starting at a terminal post. Then slide tension bar thru the last link in your fabric and attach this combination to the terminal post using tension band and bolts provided. (See Figure 10.) If more or less fabric is needed to span the opening, an additional amount can be connected or removed as shown in Figure 11. The fabric should be on the outside face of all posts and loosely attached to the top rail by a tie wire.

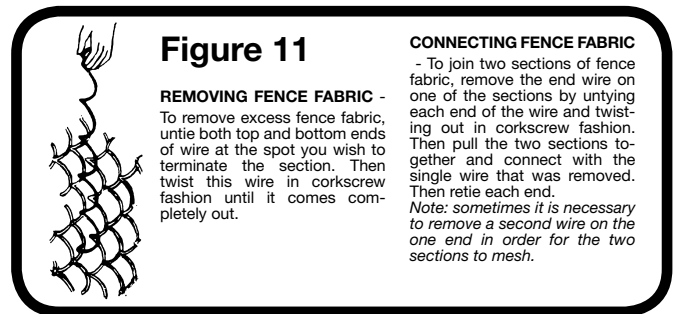
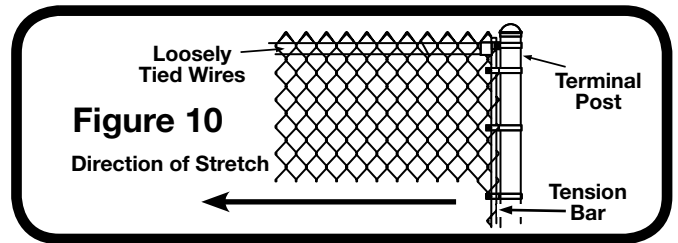

STEP 7 - STRETCH FABRIC

Fabric should be stretched from the terminal post already attached to the opposite terminal post. Insert tension bar in end of fabric and attach fence stretcher to bar (ratchet type power pull, large carpenter's clamps, block and tackle, or similar device may be used. Most wire stretching tools of this type can be rented or borrowed locally.)

As you stretch the fabric test it for tension (it is stretched enough when it gives slightly). The top of the fabric should be located approximately 1/2" above the top rail to insure proper height. After fence fabric is sufficiently tight, remove the excess fabric as shown in Figure 11, and connect the tension bar to the post with tension bands. Also fasten the fabric to the top rail and line posts with tie wires spaced approximately 18" apart.

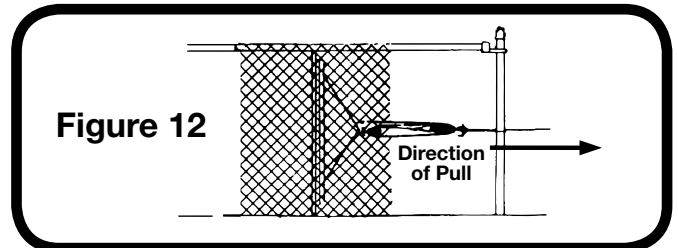
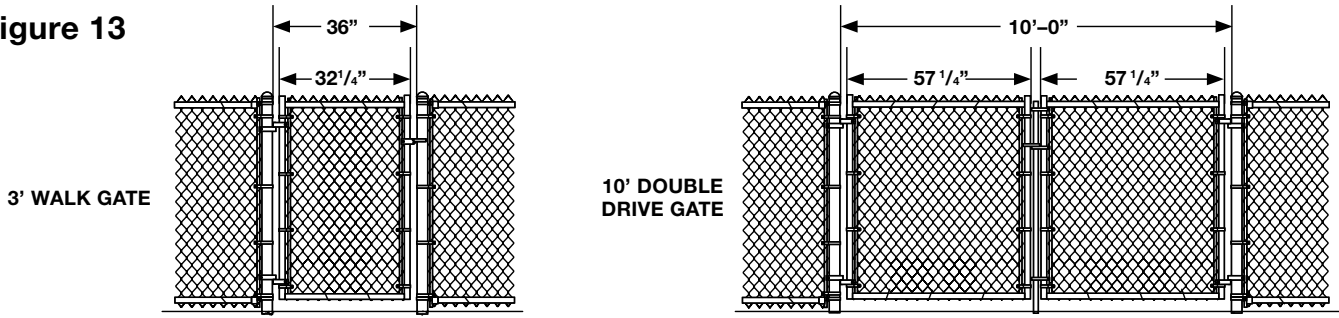

Figure 13



STEP 8 - HANG GATES

After the entire fence has been completed, apply male hinges to one of the gate posts, hanging the top hinge upside down thus preventing the gate from being lifted off. Loosely apply female hinges on the gate frame and slip them onto the male hinges that have been installed on the gate post. Set hinges to allow for full swing of the gate and align the top of the gate with the top of the fence. Tighten all hinges securely. Install gate latch for single gates. For double gates, use the same procedure as on walk gates but install center latching device (fork latch).

MATERIALS NEEDED FOR RESIDENTIAL CHAIN LINK FENCE

PIECES	ITEM-DESCRIPTION	QUANTITY TO USE	<p style="text-align: center;">TOOLS YOU WILL FIND USEFUL WHEN INSTALLING YOUR CHAIN LINK FENCE</p> <ol style="list-style-type: none"> 1. Post hole digger 2. Wheelbarrow, shovel and hoe to mix and transport 3. Tape measure 4. Level 5. String and stakes or mason's line 6. Hacksaw or pipe cutter 7. Pliers 8. Fence stretcher (block & tackle, ratchet type power pull, etc.) 9. 1/2" x 9/16" wrench or crescent wrench
(1)	Fabric (50 feet per roll)	Divide total footage by 50 and round up	
(2)	Top Rail Swedged End 1 3/8" or 1 5/8" O.D.	Total footage	
(3)	Line Post 1 5/8" or 2" O.D.	Divide total footage by 10 and round up	
(4)	Loop Caps match to post and rail	Use 1 per line post	
(5)	Terminal Post 2" or 2 1/2" O.D.	—	
(6)	Tension Bar	Use 1 per end or gate post, 2 per corner post	
(7)	Brace Band	Use 1 per tension bar	
(8)	Rail Ends	Use 1 per tension bar	
(9)	Tension Band	Use 4 per tension bar or 1' per foot of fence height	
(10)	5/16" x 1 1/4" Carriage Bolts	Use 1 per tension or brace band	
(11)	Terminal Post Caps	Use 1 per terminal post	
(12)	Alum Hook Ties	Use 1 per foot of fence— Packaged 100 per bag	
(13)	Walk Gate (3' or 3 1/2' wide)	—	
(14)	Double Drive Gate (10' or 12' wide)	—	
(15)	Male Hinge	Use 2 per walk gate and 4 per double drive gate	
(16)	3/8" x 3" Carriage Bolts	Used with the male hinge, 1 per hinge	
(17)	Female Hinge 1 3/8"	Use 2 per walk gate and 4 per double drive gate	
(18)	3/8" x 1 3/4" Carriage Bolts	Used with female hinge, 1 per hinge	
(19)	Fork Latch	Needed on walk gates	

Disclaimer: The Chain Link Fence Manufacturers Institute (CLFMI) is a not-for-profit organization and has provided all information in this publication, "Step by Step Method for Installing Your Own Chain Link Fence", as a public service. While every effort has been made to provide accurate information, neither the CLFMI nor its members make any warranties, express or implied, as to the adequacy or accuracy or fitness for a particular purpose of the instructions, diagrams and other information in this publication. The CLFMI and Eastern Wholesale Fence LLC bear no responsibility for any errors or omissions in this publication. Users shall bear all risks from using the information in this publication

VINYL COATED COLOR CHAIN LINK FABRIC



AVAILABLE COLORS: EASTERN GREEN (EG), BLACK (BK), BROWN (BR), WHITE (WT) | SPECIAL COLORS AVAILABLE

SPECIALS: Set up charges apply to special heights, colors, selvage, smaller mesh sizes, and minimum runs. Call for quotes on 6 and 3-gauge fabrics.



SYSTEM 21 COLOR VINYL COATED RESIDENTIAL 2" x 9-GAUGE FABRIC

Item No.	Description	Height	Price Per Foot Less Than 1000 Ft.	1,000 Ft. +	2,000 Ft. +
3V29-	2" x 9-Gauge Vinyl Fabric	3'			
42V29-	2" x 9-Gauge Vinyl Fabric	42"			
4V29-	2" x 9-Gauge Vinyl Fabric	4'			
5V29-	2" x 9-Gauge Vinyl Fabric	5'			
6V29-	2" x 9-Gauge Vinyl Fabric	6'			
7V29-	2" x 9-Gauge Vinyl Fabric	7'			
8V29-	2" x 9-Gauge Vinyl Fabric	8'			
10V29-	2" x 9-Gauge Vinyl Fabric	10'			
12V29-	2" x 9-Gauge Vinyl Fabric	12'			

SYSTEM 21 COLOR VINYL COATED RESIDENTIAL 2" x 6-GAUGE FABRIC

Item No.	Description	Height	Price Per Foot Less Than 1000 Ft.	1,000 Ft. +	2,000 Ft. +
4V26-	2" x 6-Gauge Vinyl Fabric	4'			
6V26-	2" x 6-Gauge Vinyl Fabric	6'			
8V26-	2" x 6-Gauge Vinyl Fabric	8'			

SYSTEM 21 COLOR VINYL COATED TENNIS COURT 1-3/4" x 9-GAUGE FABRIC

Item No.	Description	Height	Price Per Foot Less Than 1000 Ft.	1,000 Ft. +	2,000 Ft. +
8V1759-	1-3/4" x 9-Gauge Vinyl Fabric	8'			
10V1759-	1-3/4" x 9-Gauge Vinyl Fabric	10'			
12V1759-	1-3/4" x 9-Gauge Vinyl Fabric	12'			

SYSTEM 21 COLOR VINYL COATED POOL FABRIC

Item No.	Description	Height	Price Per Foot Less Than 1000 Ft.	1,000 Ft. +	2,000 Ft. +
4V1259-	1-1/4" x 9-Gauge Vinyl Fabric	4'			
4V12511-	1-1/4" x 11-Gauge Vinyl Fabric	4'			
5V12511-	1-1/4" x 11-Gauge Vinyl Fabric	5'			
6V12511-	1-1/4" x 11-Gauge Vinyl Fabric	6'			

OTHER HEIGHTS, LINK SIZES, AND WIRE GAUGES AVAILABLE UPON REQUEST

EASTERN SYSTEM 21™ “The Color Fence System Of The Twenty First Century”

Specs: 3-4 Mills Bonded Polyester Powder Coating
Colors: Black - (BK), Brown - (BR), Eastern Green - (EG)

RESIDENTIAL - LT. COMMERCIAL SIZES

Item #	Nominal O.D.	Bndl. Count	Wall	Length	Loose Ea.	Per Ea. Bundle	Per 5 Bundle
21-R1321	1-3/8" x 21' SWG Color	91	0.055	21'SW			
21-1522	1-5/8" x 22' SWG Color (Black Only)	61	0.065	22'			
21-1524	1-5/8" x 24' Color	61	0.065	24'			
21-224	2" x 24' Color	61	0.065	24'			
21-2521	2-1/2" x 21' Color	37	0.065	21'			
21-2524	2-1/2" x 24' Color	37	0.065	24'			
21-321	.120 3" x 21' Color	19	0.12	21'			
21-324	.120 3" x 24' Color	19	0.12	24'			

CUT PIPE

Item #	Length	Bndl. Count	Loose Ea.	Per Ea. Bundle	Per 5 Bundle
1-5/8" CUT POSTS	1.22 LBS. PER FT.				
21-1506-	1-5/8" x 6' Color	61			
21-1507-	1-5/8" x 7' Color	61			
21-1508-	1-5/8" x 8' Color	61			
21-15 other cuts	1-5/8" PER FT. PRICE OTHER CUTS				
2" CUT POSTS	1.41 LBS. PER FT.				
21-206-	2" x 6' Color	61			
21-207-	2" x 7' Color	61			
21-208-	2" x 8' Color	61			
21-2 other cuts	2" PER FT. PRICE OTHER CUTS				
2-1/2" CUT POSTS	1.60 LBS. PER FT.				
21-2506-	2-1/2" x 6' Color	37			
21-2507-	2-1/2" x 7' Color	37			
21-2508-	2-1/2" x 8' Color	37			
21-25 other cuts	2-1/2" PER FT. PRICE OTHER CUTS				
3" CUT POSTS	.120 WALL • 3.53 LBS. PER FT.				
21-308-	3" x 8' .120 Wall Color	19			
21-3106-	3" x 10-1/2' .120 Wall Color	19			
21-313-	3" x 13' .120 Wall Color	19			
21-3 other cuts	3" PER FT. PRICE OTHER CUTS				

EASTERN SYSTEM 21™ “The Color Fence System Of The Twenty First Century”

Specs: 3-4 Mills Bonded Polyester Powder Coating

COLOR: BLACK-BK, EASTERN GREEN-EG, BROWN-BR

SYSTEM 21™ SPEC. INDUSTRIAL SIZES - COMMERCIAL/TENNIS COURT

Item #	Nominal O.D.	Bndl. Count	Wall	Length	Loose Ea.	Per Ea. Bundle	Per 5 Bundle
21-SS1521-	1-5/8" x 21' SWG Color	61	0.095	21'SW			
21-SS224-	2" x 24' Color	61	0.095	24'			
21-SS2521-	2-1/2" x 21' Color	37	0.11	21'			
21-SS2524-	2-1/2" x 24' Color	37	0.11	24'			
21-321-	3" x 21' Color	19	0.12	21'			

CUT PIPE

Item #	Length	Bndl. Count	Loose Ea.	Per Ea. Bundle	Per 5 Bundle
2-1/2" CUT POSTS	.110 WALL • 2.64 LBS. PER FT. • 55,000 PSI				
21-SS2508-	2-1/2" x 8' .110 Wall Color	37			
21-SS25106-	2-1/2" x 10-1/2' .110 Wall Color	37			
21-SS2512-	2-1/2" x 12' .110 Wall Color	37			
21-SS2513-	2-1/2" x 13' .110 Wall Color	37			

21-SS25 other cuts 2-1/2" PER FT. PRICE OTHER CUTS

3" CUT POSTS	.120 WALL • 3.53 LBS. PER FT. • 55,000 PSI				
21-308-	3" x 8' .120 Wall Color	19			
21-3106-	3" x 10-1/2' .120 Wall Color	19			
21-312-	3" x 12' .120 Wall Color	19			
21-313-	3" x 13' .120 Wall Color	19			

21-3 other cuts 3" PER FT. PRICE OTHER CUTS

EASTERN VINYL SYSTEM III & IV Spec. Industrial Framework

System III Specs: Conforms to Federal Specification RRF-191/3C, Class 1, Grade B

System IV Specs: 1.8 oz. per sq. ft. coating conforms to Federal Specification RRF-191/3C CLASS 1, Grade A, and ASTM F1083

COLOR: BLACK-BK, EASTERN GREEN-EG, BROWN-BR

INDUSTRIAL AND SPEC. - LT. COMMERCIAL SIZES

Item #	Description	Nominal O.D.	Wall	Length	Bndl. Count	Loose Ea.	Per Ea. Bundle	Per 5 Bundle
SY31521-	1-5/8" x 21' Bonded PVC Coated SS-40	1-5/8"	0.111	21'	61			
SY3224-	2" x 24' Bonded PVC Coated SS-40	2"	0.12	24'	61			
SY32521-	2-1/2" x 21' Bonded PVC Coated SS-40	2-1/2"	0.13	21'	37			
SY32524-	2-1/2" x 24' Bonded PVC Coated SS-40	2-1/2"	0.13	24'	37			
SY3321-	3" x 21' Bonded PVC Coated SS-40	3"	0.16	21'	19			
SY3324-	3" x 24' Bonded PVC Coated SS-40	3"	0.16	24"	19			
SY4421-	4" x 21' Bonded PVC Coated SCH 40	4"	0.16	21'	19			
SY4621	6-5/8" x 21' Bonded PVC Coated SCH 40	6-5/8"	0.28	21'	7			
SY3/4 CUTS	PER FT. PRICE OTHER CUTS CALL FOR BUNDLE QUOTES							

CUT PIPE

Call for Quote

PHYSICAL PROPERTIES

Framework is manufactured from high tensile steel and cold-formed for exceptional strength. SS40 fence pipe is manufactured in full compliance with ASTM F-1043.

SUPERIOR CORROSION RESISTANCE

After the in-line galvanizing process, a three mil. coating of high-quality color polyester is applied and heat set.

DURABLE FINISH

The result is a durable finish that will retain its beauty for years to come even under the most severe conditions.

SIZE • WEIGHT • BUNDLE DATA

Nominal O.D.	Wall	Lbs./Ft.	Pcs./Bndl.
1-5/8"	.111	1.863	61
2"	.120	2.28	61
2-1/2"	.130	3.12	61
3"	.160	4.64	37
4"	.160	6.560	19
6-5/8"	.280	18.97	19

COLOR CHAIN LINK FITTINGS

System21™
COLOR CHAIN LINK FENCE

COLOR: BLACK-BK, EASTERN GREEN-EG, BROWN-BR

ALUMINUM LINE TOPS

Item #	Size	Description	Case Qty.	Loose	Case
ALT153-*	1-5/8" x 1-3/8"	Color Aluminum Line Post Top	200		
ALT213-*	2" x 1-3/8"	Color Aluminum Line Post Top	100		
ALT215-*	2" x 1-5/8"	Color Aluminum Line Post Top	100		
ALT255-*	2-1/2" x 1-5/8"	Color Aluminum Line Post Top	100		



GALVANIZED LINE TOP

Item #	Size	Description	Case Qty.	Loose	Case
GLT215-*	2" x 1-5/8"	Color Galvanized Steel Line Post Top	100		
GLT255-*	2-1/2" x 1-5/8"	Color Galvanized Steel Line Post Top	100		
GLT315-*	3" x 1-5/8"	Color Galvanized Steel Line Post Top	100		



ALUMINUM POST CAPS

Item #	Size	Description	Case Qty.	Loose	Case
APC138-*	1-3/8"	Color Aluminum Cap	100		
APC158-*	1-5/8"	Color Aluminum Cap	100		
APC200-*	2"	Color Aluminum Cap	100		
APC250-*	2-1/2"	Color Aluminum Cap	50		
APC300-*	3"	Color Aluminum Cap	50		



GALVANIZED POST CAPS

Item #	Size	Description	Case Qty.	Loose	Case
GPC250-*	2-1/2"	Color Galvanized Steel Cap	100		
GPC300-*	3"	Color Galvanized Steel Cap	100		
GPC400-*	4"	Color Galvanized Steel Cap	25		
GPC658-*	6-5/8"	Color Galvanized Steel Cap	10		



ALUMINUM RAIL ENDS

Item #	Size	Description	Case Qty.	Loose	Case
ARE138-*	1-3/8"	Color Aluminum Rail End	500		
ARE158-*	1-5/8"	Color Aluminum Rail End	250		



*** = COMBINE 10 CASES OF ANY SYSTEM 21 OR GALV. CHAIN LINK FITTINGS WITH AN ASTERISK FOR A 20% DISCOUNT**

COLOR CHAIN LINK FITTINGS

COLOR: BLACK-BK, EASTERN GREEN-EG, BROWN-BR

BEVELED TENSION BANDS

Item #	Size	Description	Case Qty.	Loose	Case
BTB138-*	1-3/8"	Color Beveled Tension Band	250		
BTB158-*	1-5/8"	Color Beveled Tension Band	250		
BTB200-*	2"	Color Beveled Tension Band	250		
BTB250-*	2-1/2"	Color Beveled Tension Band	250		
BTB300-*	3"	Color Beveled Tension Band	100		
BTB400-*	4"	Color Beveled Tension Band	100		
BTB658-*	6-5/8"	Color Beveled Tension Band	100		



BEVELED BRACE BANDS

Item #	Size	Description	Case Qty.	Loose	Case
BBB138-*	1-3/8"	Color Beveled Brace Band	250		
BBB158-*	1-5/8"	Color Beveled Brace Band	250		
BBB200-*	2"	Color Beveled Brace Band	250		
BBB250-*	2-1/2"	Color Beveled Brace Band	250		
BBB300-*	3"	Color Beveled Brace Band	100		
BBB400-*	4"	Color Beveled Brace Band	100		
BBB658-*	6-5/8"	Color Beveled Brace Band	50		



GATE CLIPS

Item #	Size	Description	Case Qty.	Loose	Case
GC138-*	1-3/8"	1-3/8" Color Gate Clip	250		



ALUMINUM AND STEEL HOOK TIES

Item #	Size	Description	Case Qty.	Loose	Case
AFT9S-*	9-Gauge x 6-3/4"	9-Gauge x 6-1/2" Aluminum Hook Tie Vinyl Coated	37		
AFT9L-*	9-Gauge x 8-1/2"	9-Gauge x 8-1/4" Aluminum Hook Tie Vinyl Coated	31		
SFT9L-*	9-Gauge x 8-1/2"	9-Gauge x 8-1/4" Steel Hook Tie Vinyl Coated	10		



FIBERGLASS AND STEEL TENSIONS BARS

Item #	Size	Description	Case Qty.	Loose	Case
FGB4-	48"	4' Fiberglass Tension Bar	25		
FGB5-	60"	5' Fiberglass Tension Bar	25		
FGB6-	72"	6' Fiberglass Tension Bar	25		
FGB7-	84"	7' Fiberglass Tension Bar	25		
FGB8-	96"	8' Fiberglass Tension Bar	25		
FGB10-	120"	10' Fiberglass Tension Bar	25		
FGB12-	144"	12' Fiberglass Tension Bar	25		
STB6-	72"	6' Color Steel Tension Bar	25		
STB8-	96"	8' Color Steel Tension Bar	25		
STB10-	120"	10' Color Steel Tension Bar	25		
STB12-	144"	12' Color Steel Tension Bar	25		



*** = COMBINE 10 CASES OF ANY SYSTEM 21 OR GALV. CHAIN LINK FITTINGS WITH AN ASTERISK FOR A 20% DISCOUNT**

COLOR CHAIN LINK FITTINGS

System21™
COLOR CHAIN LINK FENCE

COLOR: BLACK-BK, EASTERN GREEN-EG, BROWN-BR

OARLOCKS

Item #	Size	Description	Case Qty.	Loose	Case
OAR138-*	1-3/8" x 1-3/8"	Color Oarlock Latch	100		
OAR213-*	2" x 1-3/8"	Color Oarlock Latch	100		
OAR215-*	2" x 1-5/8"	Color Oarlock Latch	100		
OAR253-*	2-1/2" x 1-3/8"	Color Oarlock Latch	100		
OAR255-*	2-1/2" x 1-5/8"	Color Oarlock Latch	100		
OAR315-*	3" x 1-5/8"	Color Oarlock Latch	100		



MALLEABLE POST HINGES

Item #	Size	Description	Case Qty.	Loose	Case
MPH200-*	2"	Color Malleable Post Hinge	50		
MPH250-*	2-1/2"	Color Malleable Post Hinge	50		
MPH300-*	3"	Color Malleable Post Hinge	50		



MALLEABLE FRAME HINGES

Item #	Size	Description	Case Qty.	Loose	Case
MFH138-*	1-3/8"	Color Malleable Frame Hinge	50		
MFH158-*	1-5/8"	Color Malleable Frame Hinge	50		



GALVANIZED SLEEVES

Item #	Size	Description	Case Qty.	Loose	Case
GSL138-*	1-3/8"	Color Galvanized Steel Sleeve	100		
GSL158-*	1-5/8"	Color Galvanized Steel Sleeve	100		



MISCELLANEOUS ITEMS

Item #	Size	Description	Case Qty.	Loose	Case
SPRAY-*	SPRAY	Touch-Up Spray Paint	12		
RDR-*	RES	Color Residential Drop Rod	25		
PFH138-*	RES	Color Drop Rod Guide 1-3/8"	100		
SCR18-*	18"	Color Aluminum Gate Scroll 18"	50		



ALUMINUM AND STEEL GATE CORNERS

Item #	Size	Description	Case Qty.	Loose	Case
AGC138-*	1-3/8"	Color Aluminum Gate Corner	100		



ALUMINUM AND STEEL GATE CORNERS

Item #	Size	Description	Case Qty.	Loose	Case
SGC158-*	1-5/8"	Color Galvanized Steel Gate Corner	50		

















*** = COMBINE 10 CASES OF ANY SYSTEM 21 OR GALV. CHAIN LINK FITTINGS WITH AN ASTERISK FOR A 20% DISCOUNT**

COLOR CHAIN LINK FITTINGS

System21™
COLOR CHAIN LINK FENCE

COLOR: BLACK-BK, EASTERN GREEN-EG, BROWN-BR

MISCELLANEOUS ITEMS

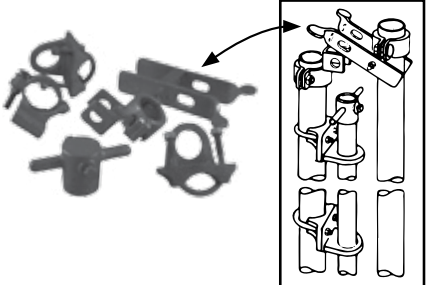
Item #	Description	Case Qty.	Loose
AHR-*	9-Gauge x 500 Pcs. Color Aluminum Hog Rings		
CW9-	9-Gauge x 500 Ft. Color 9-Gauge Straight Coil Wire x 500'		
CW6-	6-Gauge x 1000 Ft. Color 6-Gauge Coil Spring Tension Wire x 1000'		
BW-	12½-Gauge x 4 Pt. x 5" x 1320 Ft. Color Barb Wire 4-PT, 1320'		
BA215-*	2" x 1-5/8" Color Barb Wire 4-PT, 1320'		
BA255-*	2-1/2" x 1-5/8" Color Barb Wire 4-PT, 1320'		
CBA250-*	2-1/2" Color Corner Barb Arm 3-ST		
CBA300-*	3" Color Corner Barb Arm 3-ST		
CBA400-*	4" Color Corner Barb Arm 3-ST		
BVD215-*	2" x 1-5/8" Color Bottom Rail Line Rail Clamp (5/16" x 2-1/2" Bolt Required)	125	
BVD255-*	2-1/2" x 1-5/8" Color Bottom Rail Line Rail Clamp (3/8" x 2-1/2" Bolt Required)	50	
BVD315-*	3" x 1-5/8" Color Bottom Rail Line Rail Clamp (3/8" x 2-1/2" Bolt Required)	50	
BVD138-*	1-3/8" x 1-3/8" Color Bottom Rail Line Rail Clamp (5/16" x 2" Bolt Required)		
BVD158-*	1-5/8" x 1-5/8" Color Bottom Rail Line Rail Clamp (5/16" x 2" Bolt Required)	24	
BVD200-*	2" x 2" Color Bottom Rail Line Rail Clamp (5/16" x 2-1/2" Bolt Required)		
EC215-*	2" x 1-5/8" Color End Rail Clamp (3/8" x 2-1/2" Bolt Required)	100	
EC255-*	2-1/2" x 1-5/8" Color End Rail Clamp (3/8" x 2-1/2" Bolt Required)	80	
EC315-*	3" x 1-5/8" Color End Rail Clamp (3/8" x 2-1/2" Bolt Required)	80	
EC138-*	1-3/8" x 1-3/8" Color End Rail Clamp (5/16" x 2" Bolt Required)	24	
EC158-*	1-5/8" x 1-5/8" Color End Rail Clamp (3/8" x 2-1/2" Bolt Required)	24	
EC200-*	2" x 2" Color End Rail Clamp (5/16" x 2-1/2" Bolt Required)		
IOH250-*	2-1/2" Color Industrial Hinge -180-MAL	12	
IOH300-*	3" Color Industrial Hinge -180-MAL	12	
IOH400-*	4" Color Industrial Hinge -180-MAL	12	
IOH658-*	6-5/8" Color Industrial Hinge -180-MAL	12	
IBH250-*	2-1/2" x 2" (or 1-5/8") Industrial Box Hinge	12	
IBH300-*	3" x 2" (or 1-5/8") Industrial Box Hinge	12	
IBH400-*	4" x 2" (or 1-5/8") Industrial Box Hinge	12	
IBH658-*	6-5/8" x 2" (or 1-5/8") Industrial Box Hinge	12	
IBH858-*	8-5/8" x 2" (or 1-5/8") Industrial Box Hinge	12	
180ATT*	180-Degree Box Hinge Adaptor (Galv Only) Industrial Box Hinge	24	
ILD-*	1-5/8" OR 2" Color Industrial Locking Device	12	

*** = COMBINE 10 CASES OF ANY SYSTEM 21 OR GALV. CHAIN LINK FITTINGS WITH AN ASTERISK FOR A 20% DISCOUNT**

SYSTEM 21 FRAMES - SPEC. COLORED FRAMEWORK - RESIDENTIAL GRADE

Welded Fabrication using System 21TM .055 wall framework

COLORS AVAILABLE: BLACK (BK), BROWN (BR), EASTERN GREEN (EG) | ***COLOR MUST BE REQUESTED WHEN ORDERING***

Frames below are filled (F) with standard 2"x9 gauge fabric excluding the 21FIG158-47

*** (Tennis gate is filled with 1-3/4" x 9 gauge wire as a standard) ***

Item No.	Nominal O.D.	Description	Opening	Height	Loose Each
21F34-	1-3/8"	Color Single Gate	36"	4'	
21F35-	1-3/8"	Color Single Gate	36"	5'	
21F36-	1-3/8"	Color Single Gate	36"	6'	
21F424-	1-3/8"	Color Single Gate	42"	4'	
21F425-	1-3/8"	Color Single Gate	42"	5'	
21F426-	1-3/8"	Color Single Gate	42"	6'	
21F44-	1-3/8"	Color Single Gate	48"	4'	
21F45-	1-3/8"	Color Single Gate	48"	5'	
21F46-	1-3/8"	Color Single Gate	48"	6'	
21F54-	1-3/8"	Color Single Gate	60"	4'	
21F55-	1-3/8"	Color Single Gate	60"	5'	
21F56-	1-3/8"	Color Single Gate	60"	6'	
21F84-	1-3/8"	Color Double Drive	96"	4'	
21F85-	1-3/8"	Color Double Drive	96"	5'	
21F86-	1-3/8"	Color Double Drive	96"	6'	
21F104-	1-3/8"	Color Double Drive	120"	4'	
21F105-	1-3/8"	Color Double Drive	120"	5'	
21F106-	1-3/8"	Color Double Drive	120"	6'	
21F124-	1-3/8"	Color Double Drive	144"	4'	
21F125-	1-3/8"	Color Double Drive	144"	5'	
21F126-	1-3/8"	Color Double Drive	144"	6'	
21FIG158-47-	1-5/8"	Color Tennis Gate	48"	7'	

*** UNFILLED FRAMES ALSO AVAILABLE ***

Note: To order unfilled frames only please use code above without the (F)

Scrolls are fastened on 4' high gates ONLY. 5' high and up are center braced.

Gates will be wrapped for shipping / Hardware sold separately

Non-stock sizes available upon request - Call for \$\$



SYSTEM 21 COLOR INDUSTRIAL WALK GATES (COMPLETE)

System21™
COLOR CHAIN LINK FENCE

SPEC COLORED INDUSTRIAL FRAMES: BLACK (BK), BROWN (BR), EASTERN GREEN (EG),

Welded Fabrication using System 21™ | ***Heavier weight pipe available upon request, call for \$***

Frames only — No fabric included | ***COLOR MUST BE REQUESTED WHEN ORDERING***

SINGLEWALK GATES

Item #	Frame Size	Opening	Height	Each Loose
21IG158-34-	1-5/8"	3' OPENING	4' High	
21IG158-35-	1-5/8"	3' OPENING	5' High	
21IG158-36-	1-5/8"	3' OPENING	6' High	
21IG158-37-	1-5/8"	3' OPENING	7' High	
21IG158-38-	1-5/8"	3' OPENING	8' High	
21IG158-44-	1-5/8"	4' OPENING	4' High	
21IG158-45-	1-5/8"	4' OPENING	5' High	
21IG158-46-	1-5/8"	4' OPENING	6' High	
21IG158-47-	1-5/8"	4' OPENING	7' High	
21IG158-48-	1-5/8"	4' OPENING	8' High	
21IG158-54-	1-5/8"	5' OPENING	4' High	
21IG158-55-	1-5/8"	5' OPENING	5' High	
21IG158-56-	1-5/8"	5' OPENING	6' High	
21IG158-57-	1-5/8"	5' OPENING	7' High	
21IG158-58-	1-5/8"	5' OPENING	8' High	
21IG200-36-	2"	3' OPENING	6' High	
21IG200-37-	2"	3' OPENING	7' High	
21IG200-38-	2"	3' OPENING	8' High	
21IG200-46-	2"	4' OPENING	6' High	
21IG200-47-	2"	4' OPENING	7' High	
21IG200-48-	2"	4' OPENING	8' High	
21IG200-56-	2"	5' OPENING	6' High	
21IG200-57-	2"	5' OPENING	7' High	
21IG200-58-	2"	5' OPENING	8' High	

FRAME ONLY

FRAME CONFIGURATIONS

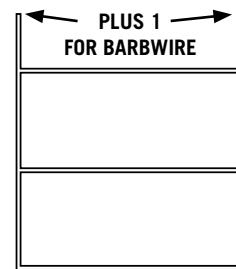
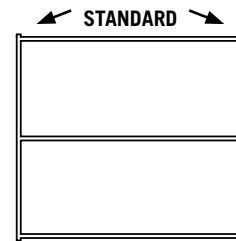

FILLED FRAME ALSO AVAILABLE

SYSTEM 21 COLOR INDUSTRIAL DOUBLE DRIVE GATES (COMPLETE)

System21™
COLOR CHAIN LINK FENCE

SPEC COLORED INDUSTRIAL FRAMES: BLACK (BK), BROWN (BR), EASTERN GREEN (EG),

Welded Fabrication using System 21™ | ***Heavier weight pipe available upon request, call for \$***

Frames only — No fabric included | ***COLOR MUST BE REQUESTED WHEN ORDERING***

DOUBLE DRIVE GATES

Item #	Frame Size	Opening	Height	Each Loose
21IG158-104-	1-5/8"	10' OPENING	4' High	
21IG158-105-	1-5/8"	10' OPENING	5' High	
21IG158-106-	1-5/8"	10' OPENING	6' High	
21IG158-107-	1-5/8"	10' OPENING	7' High	
21IG158-108-	1-5/8"	10' OPENING	8' High	
21IG158-124-	1-5/8"	12' OPENING	4' High	
21IG158-125-	1-5/8"	12' OPENING	5' High	
21IG158-126-	1-5/8"	12' OPENING	6' High	
21IG158-127-	1-5/8"	12' OPENING	7' High	
21IG158-128-	1-5/8"	12' OPENING	8' High	
21IG158-144-	1-5/8"	14' OPENING	4' High	
21IG158-145-	1-5/8"	14' OPENING	5' High	
21IG158-146-	1-5/8"	14' OPENING	6' High	
21IG158-147-	1-5/8"	14' OPENING	7' High	
21IG158-148-	1-5/8"	14' OPENING	8' High	
21IG158-164-	1-5/8"	16' OPENING	4' High	
21IG158-165-	1-5/8"	16' OPENING	5' High	
21IG158-166-	1-5/8"	16' OPENING	6' High	
21IG158-167-	1-5/8"	16' OPENING	7' High	
21IG158-168-	1-5/8"	16' OPENING	8' High	
21IG158-184-	1-5/8"	18' OPENING	4' High	
21IG158-185-	1-5/8"	18' OPENING	5' High	
21IG158-186-	1-5/8"	18' OPENING	6' High	
21IG158-187-	1-5/8"	18' OPENING	7' High	
21IG158-188-	1-5/8"	18' OPENING	8' High	
21IG200-106-	2"	10' OPENING	6' High	
21IG200-107-	2"	10' OPENING	7' High	
21IG200-108-	2"	10' OPENING	8' High	
21IG200-126-	2"	12' OPENING	6' High	
21IG200-127-	2"	12' OPENING	7' High	
21IG200-128-	2"	12' OPENING	8' High	
21IG200-146-	2"	14' OPENING	6' High	
21IG200-147-	2"	14' OPENING	7' High	
21IG200-148-	2"	14' OPENING	8' High	
21IG200-166-	2"	16' OPENING	6' High	
21IG200-167-	2"	16' OPENING	7' High	
21IG200-186-	2"	18' OPENING	6' High	
21IG200-187-	2"	18' OPENING	7' High	
21IG200-188-	2"	18' OPENING	8' High	
21IG200-226-	2"	22' OPENING	6' High	
21IG200-227-	2"	22' OPENING	7' High	
21IG200-228-	2"	22' OPENING	8' High	
21IG200-266-	2"	26' OPENING	6' High	
21IG200-267-	2"	26' OPENING	7' High	
21IG200-268-	2"	26' OPENING	8' High	
21IG200-306-	2"	30' OPENING	6' High	
21IG200-307-	2"	30' OPENING	7' High	
21IG200-308-	2"	30' OPENING	8' High	

FRAME ONLY

FRAME CONFIGURATIONS

Up to 10' Wide
(Price Includes 2 leaves)

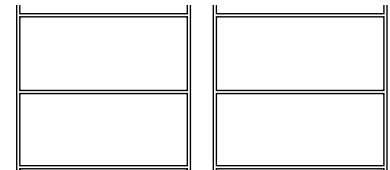

12' to 24' Wide
(Price Includes 2 leaves)

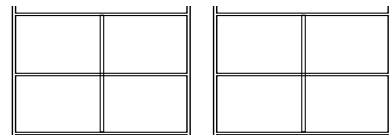

26' to 30' Wide
(Price Includes 2 leaves)
(“K” Brace Recommended)

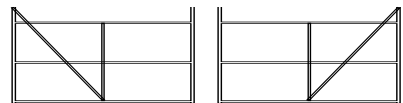

SWING GATE RECOMMENDED POST SIZES		
	MAXIMUM SINGLE	MAXIMUM DOUBLE
3" O.D.	6'	12'
4" O.D.	13'	26'
6-5/8" O.D.	18'	36'
8-5/8" O.D.	18' UP	36' UP

**FILLED
FRAME ALSO
AVAILABLE**

COMMERCIAL GALVANIZED CHAIN LINK FABRIC



GALVANIZED CHAIN LINK FABRIC

Including 2" Mesh x 9-Gauge Galv. Fabric, 2" Mesh x 6-Gauge Galv. Fabric,
and 2-3/8" Mesh x 12.5-Gauge Galv. Fabric



2" MESH HOT-DIP GALVANIZED CHAIN LINK FABRIC

1.2 OZ | MEETS FEDERAL SPECIFICATIONS RRF-191/1B, TYPE 1, CLASS 1, AND ASTM A392, CLASS 1

Item No.	Description	Height	Price/Ft. < 1000 Ft.	Price/Ft. > 1000 Ft.
3G29	2" Mesh x 9-Gauge Galv. Fabric	3'		
42G29	2" Mesh x 9-Gauge Galv. Fabric	42"		
4G29	2" Mesh x 9-Gauge Galv. Fabric	4'		
5G29	2" Mesh x 9-Gauge Galv. Fabric	5'		
6G29	2" Mesh x 9-Gauge Galv. Fabric	6'		
7G29	2" Mesh x 9-Gauge Galv. Fabric	7'		
8G29	2" Mesh x 9-Gauge Galv. Fabric	8'		
10G29	2" Mesh x 9-Gauge Galv. Fabric	10'		
12G29	2" Mesh x 9-Gauge Galv. Fabric	12'		
6G26	2" Mesh x 6-Gauge Galv. Fabric	6'		
8G26	2" Mesh x 6-Gauge Galv. Fabric	8'		
10G26	2" Mesh x 6-Gauge Galv. Fabric	10'		
12G26	2" Mesh x 6-Gauge Galv. Fabric	12'		

NOTE: 2.0 oz. coating to meet RRF-191/1B, Type 1, Class 2, or ASTM A392, Class 2, is also available. Price upon request.

2-3/8" MESH HOT-DIP GALVANIZED CHAIN LINK FABRIC

Item No.	Description	Height	Price/Ft. < 1000 Ft.	Price/Ft. > 1000 Ft.
4G23812	2-3/8" Mesh x 12.5-Gauge Galv. Fabric	4'		
5G23812	2-3/8" Mesh x 12.5-Gauge Galv. Fabric	5'		
6G23812	2-3/8" Mesh x 12.5-Gauge Galv. Fabric	6'		
8G23812	2-3/8" Mesh x 12.5-Gauge Galv. Fabric	8'		

GALVANIZED RESI WEIGHT PIPE



TRIPLE COATED - FOR BETTER CORROSION RESISTANCE!

MILL LENGTHS

Item #	Nominal O.D.	Wall	Length	Loose Ea.	Per Ea. Bundle	Per Ea. 5 Bundles
R1321	1-3/8" x 21' Resi Weight Pipe SWG	.055	21'SW			
R1324	1-3/8" x 24' Resi Weight Pipe	.055	24'			
R1524	1-5/8" x 24' Resi Weight Pipe	.055	24'			

CUT POSTS (All prices are "per each")

Item #	Nominal O.D.	Wall	Length	Loose Ea.	Per Ea. Bundle	Per Ea. 5 Bundles
R1506	1-5/8" x 6' Resi Weight Pipe	.055	6'			
R1507	1-5/8" x 7' Resi Weight Pipe	.055	7'			
R1521/24	ALL OTHER 1-5/8" CUTS AT \$ _____ PER FT.					

SIZE • WEIGHT • BUNDLE DATA

Nominal O.D.	Wall	Lbs./Ft.	Pcs./Bndl.
1-3/8"	.055	.770	91
1-5/8"	.055	.943	61

PROUDLY "MADE IN THE USA"
ALL OTHER SIZES & GAUGES AVAILABLE UPON REQUEST

SS-15 GALVANIZED PIPE



Proudly "Made In the USA"
 EQUAL IN PERFORMANCE TO 1.80 oz. GALVANIZED
 Performance proven protection - Both inside and outside

MILL LENGTHS

Item #	Nominal O.D.	Wall	Length	Loose Ea.	Per Ea. Bundle	Per Ea. 5 Bundles
15-1321	1-3/8" x 21' Resi Weight Pipe SWG	.065	21' SW			
15-1521	1-5/8" x 21' Resi Weight Pipe	.065	21'			
15-1524	1-5/8" x 24' Resi Weight Pipe	.065	24'			
15-221	2" x 21' Resi Weight Pipe	.065	5'			
15-224	2" x 24' Resi Weight Pipe	.065	6'			
15-2521	2-1/2" x 21' Resi Weight Pipe	.065	8'			
15-2524	2-1/2" x 24' Resi Weight Pipe	.065	10'			

CUT POSTS (All prices are "per each")

Item #	Nominal O.D.	Wall	Length	Loose Ea.	Per Ea. Bundle	Per Ea. 5 Bundles
15-1506	1-5/8" x 6' SS-15 Pipe	.065	6'			
15-1507	1-5/8" x 7' SS-15 Pipe	.065	7'			
15-1521/24	ALL OTHER 1-5/8" CUTS AT \$ _____ PER FT.					
15-206	2" x 6' SS-15 Pipe	.065	6'			
15-207	2" x 7' SS-15 Pipe	.065	7'			
15-208	2" x 8' SS-15 Pipe	.065	8'			
15-221/24	ALL OTHER 2" CUTS AT \$ _____ PER FT.					
15-2506	2-1/2" x 6' SS-15 Pipe	.065	6'			
15-2507	2-1/2" x 7' SS-15 Pipe	.065	7'			
15-2508	2-1/2" x 8' SS-15 Pipe	.065	8'			
15/2521/24	ALL OTHER 2-1/2" CUTS AT \$ _____ PER FT.					

SIZE • WEIGHT • BUNDLE DATA

Nominal O.D.	Wall	Lbs./Ft.	Pcs./Bndl.
1-3/8"	.065	0.87	91
1-5/8"	.065	1.11	61
2"	.065	1.27	61
2-1/2"	.065	1.60	37

OUTPERFORMS LITE STRUCTURAL PIPE IN ALL PERFORMANCE AREAS

SS-20 GALVANIZED PIPE



Outperforms Structural Pipe

MILL LENGTHS

Item #	Nominal O.D.	Wall	Length	Loose Ea.	Per Ea. Bundle	Per Ea. 5 Bundles
20-1321	1-3/8" x 21' SS-20 Pipe	.080	21'			
20-1521	1-5/8" x 21' SS-20 Pipe	.085	21'SW			
20-1524	1-5/8" x 24' SS-20 Pipe	.085	24'			
20-221	2" x 21' SS-20 Pipe	.090	21'			
20-224	2" x 24' SS-20 Pipe	.090	24'			
20-2521	2-1/2" x 21' SS-20 Pipe	.095	21'			
20-2524	2-1/2" x 24' SS-20 Pipe	.095	24'			
20-321	3" x 21' SS-20 Pipe	.110	21'			
20-324	3" x 24' SS-20 Pipe	.110	24'			

CUT POSTS (All prices are "per each")

Item #	Nominal O.D.	Wall	Length	Loose Ea.	Per Ea. Bundle	Per Ea. 5 Bundles
20-1506	1-5/8" x 6' SS-20 Pipe	.085	6'			
20-1507	1-5/8" x 7' SS-20 Pipe	.085	7'			
20-1508	1-5/8" x 8' SS-20 Pipe	.085	8'			
20-1521/24	ALL OTHER 1-5/8" CUTS AT \$ _____ PER FT.					
20-206	2" x 6' SS-20 Pipe	.090	6'			
20-207	2" x 7' SS-20 Pipe	.090	7'			
20-208	2" x 8' SS-20 Pipe	.090	8'			
20-221/24	ALL OTHER 2" CUTS AT \$ _____ PER FT.					
20-2506	2-1/2" x 6' SS-20 Pipe	.095	6'			
20-2507	2-1/2" x 7' SS-20 Pipe	.095	7'			
20-2508	2-1/2" x 8' SS-20 Pipe	.095	8'			
20-2521/24	ALL OTHER 2-1/2" CUTS AT \$ _____ PER FT.					
20-321/24	ALL OTHER 3" CUTS AT \$ _____ PER FT. .110					

SIZE • WEIGHT • BUNDLE DATA

Nominal O.D.	Wall	Lbs./Ft.	Pcs./Bndl.
1-3/8"	.080	1.056	91
1-5/8"	.085	1.431	61
2"	.090	1.741	61
2-1/2"	.095	2.315	37
3"	.110	3.251	30

OUTPERFORMS LITE STRUCTURAL PIPE IN ALL PERFORMANCE AREAS

SS-40 GALVANIZED PIPE



Outperforms Schedule 40 Pipe!

Conforms to FEDERAL SPECIFICATION RRF-191/3C, CLASS 1, GRADE B

MILL LENGTHS

Item #	Nominal O.D.	Wall	Length	Loose Ea.	Per Ea. Bundle	Per Ea. 5 Bundles
40-1321	1-3/8" x 21' SS-40 Pipe	.104	21'			
40-1521	1-5/8" x 21' SS-40 Pipe	.111	21'			
40-1524	1-5/8" x 24' SS-40 Pipe	.111	24'			
40-218	2" x 18' SS-40 Pipe	.120	18'			
40-221	2" x 21' SS-40 Pipe	.120	21'			
40-224	2" x 24' SS-40 Pipe	.120	24'			
40-2518	2-1/2" x 18' SS-40 Pipe	.130	18'			
40-2521	2-1/2" x 21' SS-40 Pipe	.130	21'			
40-2524	2-1/2" x 24' SS-40 Pipe	.130	24'			
40-321	3" x 21' SS-40 Pipe	.160	21'			
40-324	3" x 24' SS-40 Pipe	.160	24'			
40-3521	3-1/2" x 21' SS-40 Pipe	.160	21'			
40-3524	3-1/2" x 24' SS-40 Pipe	.160	24'			
40-421	4" x 21' SS-40 Pipe	.160	21'			
40-424	4" x 24' SS-40 Pipe	.160	24'			

CUT POSTS (All prices are "per each")

Item #	Nominal O.D.	Wall	Length	Loose Ea.	Per Ea. Bundle	Per Ea. 5 Bundles
40-1506	1-5/8" x 6' SS-40 Pipe	.111	6'			
40-1507	1-5/8" x 7' SS-40 Pipe	.111	7'			
40-1508	1-5/8" x 8' SS-40 Pipe	.111	8'			
40-1521/24	ALL OTHER 1-5/8" CUTS AT \$ _____ PER FT.					
40-206	2" x 6' SS-40 Pipe	.120	6'			
40-207	2" x 7' SS-40 Pipe	.120	7'			
40-208	2" x 8' SS-40 Pipe	.120	8'			
40-221-24	ALL OTHER 2" CUTS AT \$ _____ PER FT.					
40-2506	2-1/2" x 6' SS-40 Pipe	.130	6'			
40-2507	2-1/2" x 7' SS-40 Pipe	.130	7'			
40-2508	2-1/2" x 8' SS-40 Pipe	.130	8'			
40-2509	2-1/2" x 9' SS-40 Pipe	.130	9'			
40-2521/24	ALL OTHER 2-1/2" CUTS AT \$ _____ PER FT.					
40-324/24	ALL OTHER 3" CUTS AT \$ _____ PER FT.	.160				
40-3521/24	ALL OTHER 3-1/2" CUTS AT \$ _____ PER FT.	.160				
40-421/24	ALL OTHER 4" CUTS AT \$ _____ PER FT.	.160				

SIZE • WEIGHT • BUNDLE DATA

Nominal O.D.	Wall	Lbs./Ft.	Pcs./Bndl.
1-3/8"	.104	1.345	91
1-5/8"	.111	1.863	61
2"	.120	2.281	61
2-1/2"	.130	3.117	37
3"	.160	4.640	30
3-1/2"	.160	5.706	19
4"	.160	6.560	19

SCHEDULE 40 GALVANIZED PIPE



1.8 OZ. PER SQ. FT. ZINC COATING

CONFORMS TO FEDERAL SPECIFICATION RRF-191/3C CLASS 1, GRADE A, AND ASTM F1083

MILL LENGTHS

Item#	Nominal O.D.	Wall	Length	No. Per Bundle	Loose Ea.	Per Ea. Bundle	Per Ea. 5 Bundles
STD1521	1-5/8" x 21' Standard Weight Pipe	.145	21'	42			
STD1524	1-5/8" x 24' Standard Weight Pipe	.145	24'	42			
STD221	2" x 21' Standard Weight Pipe	.145	21'	36			
STD224	2" x 24' Standard Weight Pipe	.145	24'	36			
STD2521	2-1/2" x 21' Standard Weight Pipe	.154	21'	26			
STD2524	2-1/2" x 24' Standard Weight Pipe	.154	24'	26			
STD321	3" x 21' Standard Weight Pipe	.203	21'	18			
STD324	3" x 24' Standard Weight Pipe	.203	24'	18			
STD421	4" x 21' Standard Weight Pipe	.226	21'	12			
STD424	4" x 24' Standard Weight Pipe	.226	24'	12			
STD621	6-5/8" x 21' Standard Weight Pipe	.280	21'	7			
STD624	6-5/8" x 24' Standard Weight Pipe	.280	24'	7			
STD821/24	8-5/8" x 21'/24' Standard Weight Pipe	.322	21'/24'	3			

SIZE • WEIGHT • BUNDLE DATA

Nominal O.D.	Wall	Lbs./Ft.
1-5/8"	.140	2.27
2"	.145	2.72
2-1/2"	.154	3.65
3"	.203	5.79
3-1/2"	.216	7.58
4"	.226	9.11
6-5/8"	.280	18.97
8-5/8"	.322	28.55

SCHEDULE 40 GALVANIZED PIPE



1.8 OZ. PER SQ. FT. ZINC COATING

CONFORMS TO FEDERAL SPECIFICATION RRF-191/3C CLASS 1, GRADE A, AND ASTM F1083

CUT SIZES

Item#	Nominal O.D.	Wall	Length	No. Per Bundle	Loose Ea.	Per Ea. Bundle	Per Ea. 5 Bundles
STD208	2" x 8' Standard Weight Pipe	.145	8'	36			
STD209	2" x 9' Standard Weight Pipe	.145	9'	36			
STD2508	2-1/2" x 8' Standard Weight Pipe	.154	8'	26			
STD2509	2-1/2" x 9' Standard Weight Pipe	.154	9'	26			
STD25106	2-1/2" x 10'-6" Standard Weight Pipe	.154	10' 6"	26			
STD2512	2-1/2" x 12' Standard Weight Pipe	.154	12'	26			

**PIPE BENDING
AND
FLANGE WELDING
NOW AVAILABLE!**

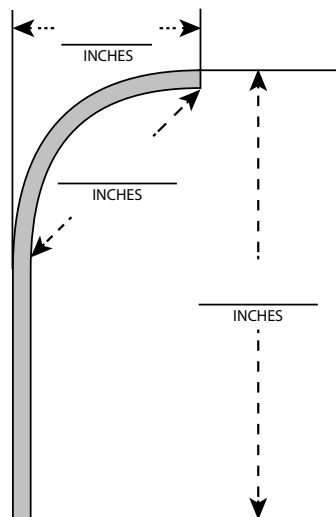

**MUST GIVE MEASUREMENTS
FOR ACCURATE BENDING**



GALVANIZED CHAIN LINK FITTINGS

ALUMINUM POST CAPS

Item #	Description	Case Qty.	Loose	Case
APC138*	1-3/8" Aluminum Post Cap	350		
APC158*	1-5/8" Aluminum Post Cap	350		
APC200*	2" Aluminum Post Cap	250		
APC250*	2-1/2" Aluminum Post Cap	150		
APC300*	3" Aluminum Post Cap	100		



GALVANIZED POST CAPS

Item #	Description	Case Qty.	Loose	Case
GPC158*	1-5/8" Galvanized Post Caps	100		
GPC200*	2" Galvanized Post Caps	75		
GPC250*	2-1/2" Galvanized Post Caps	50		
GPC300*	3" Galvanized Post Caps	50		
GPC350*	3-1/2" Galvanized Post Caps	25		
GPC400*	4" Galvanized Post Caps	25		
GPC658*	6-5/8" Galvanized Post Caps	10		
GPC858*	8-5/8" Galvanized Post Caps	8		



ALUMINUM DOME CAP

Item #	Description	Case Qty.	Loose	Case
ADC138*	1-3/8" Aluminum Dome Cap	350		



ALUMINUM PLUGS

Item #	Description	Case Qty.	Loose	Case
AP158*	1-5/8" Aluminum Plug	250		
AP200*	2" Aluminum Plug	250		



* = COMBINE 10 CASES OF ANY SYSTEM 21 OR GALV. CHAIN LINK FITTINGS WITH AN ASTERISK FOR A 20% DISCOUNT

GALVANIZED CHAIN LINK FITTINGS

ALUMINUM LINE TOPS

Item #	Description	Case Qty.	Loose	Case
ALT153*	1-5/8" x 1-3/8" Aluminum Line Top	200		
ALT213*	2" x 1-3/8" Aluminum Line Top	200		
ALT215*	2" x 1-5/8" Aluminum Line Top	100		
ALT255*	2-1/2" x 1-5/8" Aluminum Line Top	100		



GALVANIZED LINE TOPS

Item #	Description	Case Qty.	Loose	Case
GLT215*	2" x 1-5/8" Galvanized Line Top	50		
GLT255*	2-1/2" x 1-5/8" Galvanized Line Top	30		
GLT315*	3" x 1-5/8" Galvanized Line Top	20		
GLT355*	3-1/2" x 1-5/8" Galvanized Line Top	20		
GLT415*	4" x 1-5/8" Galvanized Line Top	30		



PRESSED STEEL LINE TOPS

Item #	Description	Case Qty.	Loose	Case
PLT153*	1-5/8" x 1-3/8" Pressed Steel Line Tops	CALL		
PLT213*	2" x 1-3/8" Pressed Steel Line Tops	50		
PLT215*	2" x 1-5/8" Pressed Steel Line Tops	50		
PLT255*	2-1/2" x 1-5/8" Pressed Steel Line Tops	50		
PLT315	3" x 1-5/8" Pressed Steel Line Tops	20		
PLT355	3-1/2" x 1 5/8" Pressed Steel Line Tops	CALL		
PLT415	4" x 1-5/8" Pressed Steel Line Tops	CALL		



GALVANIZED SLEEVES

Item #	Description	Case Qty.	Loose	Case
GSL138*	1-3/8" Galvanized Sleeve	100		
GSL158*	1-5/8" Galvanized Sleeve	100		



* = COMBINE 10 CASES OF ANY SYSTEM 21 OR GALV. CHAIN LINK FITTINGS WITH AN ASTERISK FOR A 20% DISCOUNT

GALVANIZED CHAIN LINK FITTINGS

TENSION BANDS - STANDARD

Item #	Description	Case Qty.	Loose	Case
PTB138*	1-3/8" Plain Tension Band	250		
PTB158*	1-5/8" Plain Tension Band	250		
PTB200*	2" Plain Tension Band	250		
PTB250*	2-1/2" Plain Tension Band	250		
PTB300*	3" Plain Tension Band	100		



TENSION BANDS - BEVELED

Item #	Description	Case Qty.	Loose	Case
BTB138*	1-3/8" Beveled Tension Band	250		
BTB158*	1-5/8" Beveled Tension Band	250		
BTB200*	2" Beveled Tension Band	250		
BTB250*	2-1/2" Beveled Tension Band	250		
BTB300*	3" Beveled Tension Band	100		
BTB350*	3-1/2" Beveled Tension Band	100		
BTB400*	4" Beveled Tension Band	100		
BTB658*	6-5/8" Beveled Tension Band	50		
BTB858*	8-5/8" Beveled Tension Band	50		



BRACE BANDS - STANDARD

Item #	Description	Case Qty.	Loose	Case
PBB158*	1-5/8" Plain Brace Band	250		
PBB200*	2" Plain Brace Band	250		
PBB250*	2-1/2" Plain Brace Band	250		
PBB300*	3" Plain Brace Band	100		



BRACE BANDS - BEVELED

Item #	Description	Case Qty.	Loose	Case
BBB138*	1-3/8" Beveled Brace Band	300		
BBB158*	1-5/8" Beveled Brace Band	300		
BBB200*	2" Beveled Brace Band	250		
BBB250*	2-1/2" Beveled Brace Band	250		
BBB300*	3" Beveled Brace Band	200		
BBB350*	3-1/2" Beveled Brace Band	100		
BBB400*	4" Beveled Brace Band	100		
BBB658*	6-5/8" Beveled Brace Band	50		
BBB858*	8-5/8" Beveled Brace Band	50		



* = COMBINE 10 CASES OF ANY SYSTEM 21 OR GALV. CHAIN LINK FITTINGS WITH AN ASTERISK FOR A 20% DISCOUNT

GALVANIZED CHAIN LINK FITTINGS

BOULEVARD CLAMPS – (Bolts Sold Separately)

Item #	Description	Bolt Required	Case Qty.	Loose	Case
BVD138*	1-3/8" x 1-3/8" Boulevard Clamps	5/16" x 2"	150		
BVD153*	1-5/8" x 1-3/8" Boulevard Clamps	5/16" x 2"	100		
BVD158*	1-5/8" x 1-5/8" Boulevard Clamps	5/16" x 2"	100		
BVD200*	2" x 2" Boulevard Clamps	5/16" x 2-1/2"	100		
BVD213*	2" x 1-3/8" Boulevard Clamps	5/16" x 2-1/2"	125		
BVD215*	2" x 1-5/8" Boulevard Clamps	5/16" x 2-1/2"	50		
BVD255*	2-1/2" x 1-5/8" Boulevard Clamps	3/8" x 2-1/2"	50		
BVD315*	3" x 1-5/8" Boulevard Clamps	3/8" x 2-1/2"	50		
BVD355*	3-1/2" x 1-5/8" Boulevard Clamps	3/8" x 2-1/2"	50		
BVD415*	4" x 1-5/8" Boulevard Clamps	3/8" x 2-1/2"	50		



END CLAMPS – (Bolts Sold Separately)

Item #	Description	Bolt Required	Case Qty.	Loose	Case
EC138*	End Clamps 1-3/8" x 1-3/8"	5/16" x 2"	100		
EC158*	End Clamps 1-5/8" x 1-5/8"	3/8" x 2-1/2"	100		
EC213*	End Clamps 2" x 1-3/8"	5/16" x 2"	100		
EC215*	End Clamps 2" x 1-5/8"	3/8" x 2-1/2"	100		
EC200*	End Clamps 2" x 2"	5/16" x 2-1/2"	100		
EC255*	End Clamps 2-1/2" x 1-5/8"	3/8" x 2-1/2"	100		
EC315*	End Clamps 3" x 1-5/8"	3/8" x 2-1/2"	100		
EC355*	End Clamps 3-1/2" x 1-5/8"	3/8" x 2-1/2"	50		
EC415*	End Clamps 4" x 1-5/8"	3/8" x 2-1/2"	100		



CORNER RAIL CLAMP – (Bolts Sold Separately)

Item #	Description	Bolt Required	Case Qty.	Loose	Case
CRC255*	Corner Rail Clamp 2-1/2" x 1-5/8"	5/16" x 2-1/2"	100		
CRC315*	Corner Rail Clamp 3" x 1-5/8"	5/16" x 2-1/2"	100		



SADDLE CLAMP – (Bolts Sold Separately)

Item #	Description	Bolt Required	Case Qty.	Loose	Case
SC138*	Saddle Clamp 1-3/8" x 1-3/8"	5/16" x 1-1/4"	100		
SC158*	Saddle Clamp 1-5/8" x 1-5/8"	3/8" x 2-1/2"	100		
SC200*	Saddle Clamp 2" x 2"	3/8" x 3"	100		



* = COMBINE 10 CASES OF ANY SYSTEM 21 OR GALV. CHAIN LINK FITTINGS WITH AN ASTERISK FOR A 20% DISCOUNT

GALVANIZED CHAIN LINK FITTINGS

ALUMINUM RAIL ENDS

Item #	Description	Case Qty.	Loose	Case
ARE138*	1-3/8" Aluminum Rail End	500		
ARE158*	1-5/8" Aluminum Rail End	250		



GALVANIZED RAIL ENDS

Item #	Description	Case Qty.	Loose	Case
GRE138*	1-3/8" Galvanized Rail End	100		
BRE158*	1-5/8" Galvanized Brace Rail End	100		
GRE200*	2" Galvanized Rail End	50		



CARRIAGE BOLTS

Item #	Description	Case Qty.	Loose	Case
NB5125*	5/16" x 1-1/4" Carriage Nuts and Bolts	20		
NB5150*	5/16" x 1-1/2" Carriage Nuts and Bolts	10		
NB5250*	5/16" x 2-1/2" Carriage Nuts and Bolts	10		
NB3150*	3/8" x 1-1/2" Carriage Nuts and Bolts	10		
NB3200*	3/8" x 2" Carriage Nuts and Bolts	10		
NB3250*	3/8" x 2-1/2" Carriage Nuts and Bolts	10		
NB3300*	3/8" x 3" Carriage Nuts and Bolts	10		
NB3350*	3/8" x 3-1/2" Carriage Nuts and Bolts	10		



* = COMBINE 10 CASES OF ANY SYSTEM 21 OR GALV. CHAIN LINK FITTINGS WITH AN ASTERISK FOR A 20% DISCOUNT

GALVANIZED CHAIN LINK FITTINGS



ALUMINUM FENCE TIES – 100 Ties Per Bag

Item No.	Description	BAGS PER CASE	PER BAG	PER BAG BY CASE	T/L
AFT9S*	9-Gauge x 6-1/2" #13 Aluminum Fence Ties	37			
AFT9L*	9-Gauge x 8-1/4" #16 Aluminum Fence Ties	31			
AFT6S*	6-Gauge x 6-1/2" #23 Aluminum Fence Ties	18			
AFT6L*	6-Gauge x 8-1/4" #26 Aluminum Fence Ties	18			

STEEL FENCE TIES, GALV. - 100 Ties Per Bag

Item No.	Description	BAGS PER CASE	PER BAG	PER BAG BY CASE	T/L
SFT9L*	9-Gauge x 8-1/4" Steel Fence Ties	10			
SFT9S	9-Gauge SHORT x 6-1/2" Steel Fence Ties	10			
SFT13*	13-Gauge x 15-1/2" Double Wrap Steel Fence Ties	20			
SFT14*	14-Gauge x 12" Double Loop Steel Fence Ties	25			

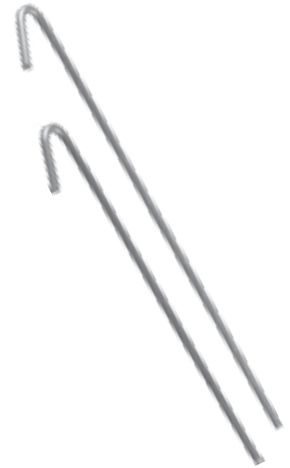

STAINLESS STEEL DOUBLE TIES

Item No.	Description	BAGS PER CASE	PER BAG	PER BAG BY CASE	T/L
RRTIESS*	18-Gauge x 8" Double Tie Stainless Steel	50			

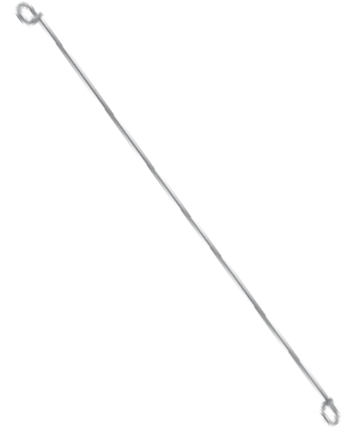

FABRIC ANCHORS - GALVANIZED STEEL

Item No.	Description	STD. PKG. QTY	PER 100	STD. PACKAGE	T/L
FAH*	Galvanized Fabric Anchors	250			



* = COMBINE 10 CASES OF ANY SYSTEM 21 OR GALV. CHAIN LINK FITTINGS WITH AN ASTERISK FOR A 20% DISCOUNT

GALVANIZED CHAIN LINK FITTINGS

POST HINGES - MALLEABLE

Item #	Description	Case Qty.	Loose	Case	T/L
MPH200*	Post Hinge - Malleable 2"	50			
MPH250*	Post Hinge - Malleable 2-1/2"	50			
MPH300*	Post Hinge - Malleable 3"	50			



POST HINGES - PRESSED STEEL

Item #	Description	Case Qty.	Loose	Case	T/L
PPH200*	2" Post Hinge - Pressed Steel	50			
PPH250*	2-1/2" Post Hinge - Pressed Steel	50			
PPH300*	3" Post Hinge - Pressed Steel	50			



WMH*	Post Hinge - Wall Mount Pin	100			
------	-----------------------------	-----	--	--	--



FRAME HINGE - MALLEABLE

Item #	Description	Case Qty.	Loose	Case	T/L
MFH138*	1-3/8" Frame Hinge - Malleable	100			
MFH158*	1-5/8" Frame Hinge - Malleable	80			



FRAME HINGE - PRESSED STEEL

Item #	Description	Case Qty.	Loose	Case	T/L
PFH138*	1-3/8" Frame Hinge - Pressed Steel	100			
PFH158*	1-5/8" Frame Hinge - Pressed Steel	80			



* = COMBINE 10 CASES OF ANY SYSTEM 21 OR GALV. CHAIN LINK FITTINGS WITH AN ASTERISK FOR A 20% DISCOUNT

GALVANIZED CHAIN LINK FITTINGS



OARLOCKS - COMPLETE

Item No.	Description	CASE QTY	Loose	PER 100
OAR138*	1-3/8" x 1-3/8" Oarlocks - Complete	100		
OAR213*	2 x 1-3/8" Oarlocks - Complete	100		
OAR253*	2-1/2" x 1-3/8" Oarlocks - Complete	100		
OAR313*	3" x 1-3/8" Oarlocks - Complete	100		
OAR215*	2" x 1-5/8" Oarlocks - Complete	100		
OAR255*	2-1/2" x 1-5/8" Oarlocks - Complete	100		
OAR315*	3" x 1-5/8" Oarlocks - Complete	100		
OAR402*	4" x 2" Oarlocks - Complete	100		



FORK ONLY

Item No.	Description	CASE QTY	Loose	PER 100
FORK138*	1-3/8" Fork Only	100		
FORK200*	2" Fork Only	100		
FORK250*	2-1/2" Fork Only	50		
FORK300*	3" Fork Only	50		
FORK400*	4" Fork Only	50		



COLLARS ONLY

Item No.	Description	CASE QTY	Loose	PER 100
COL138*	1-3/8" Collar Only	100		
COL158*	1-5/8" Collar Only	100		
COL200*	2" Collar Only	100		



DROP FORK BRACKETS

Item No.	Description	CASE QTY	EACH LOOSE	PER 100
DFB*	Drop Fork Bracket	100		



* = COMBINE 10 CASES OF ANY SYSTEM 21 OR GALV. CHAIN LINK FITTINGS WITH AN ASTERISK FOR A 20% DISCOUNT

GALVANIZED CHAIN LINK FITTINGS



AUTO LATCH - CHILD PROOF LATCH (Other Sizes Available)

Item No.	Description	CASE QTY	LOOSE	25 EACH
AUT0138	1-3/8" x 1-3/8" Auto Latch - Child Proof	25		
AUT0213	2" x 1-3/8" Auto Latch - Child Proof	25		
AUT0215	2" x 1-5/8" Auto Latch - Child Proof	25		
AUT0253	2-1/2" x 1-3/8" Auto Latch - Child Proof	25		
AUT0255	2-1/2" x 1-5/8" Auto Latch - Child Proof	25		
AUT0315	3" x 1-5/8" Auto Latch - Child Proof	25		



MAGNA LATCH - MAGNETIC LATCHING-KEY LOCKING

Item No.	Description	CASE QTY	LOOSE	25 EACH
MLDD-BK/WT	Magnetic Latch Top Pull, BK or WT	15		
MLS-BK/WT	Magnetic Latch Vertical Pull, BK or WT	10		
MLA-	Magna-Latch C/L Adaptor	25		



KENNEL LATCH

Item No.	Description	CASE QTY	LOOSE	10 EACH
KL*	1-3/8" x 1-3/8" Kennel Latch	25		



CLAW CLOSER

Item No.	Description	CASE QTY	LOOSE	50 EACH
CC213*	2" x 1-3/8" Claw Closer	12		
CC253*	2-1/2" x 1-3/8" Claw Closer	12		



* = COMBINE 10 CASES OF ANY SYSTEM 21 OR GALV. CHAIN LINK FITTINGS WITH AN ASTERISK FOR A 20% DISCOUNT

GALVANIZED CHAIN LINK FITTINGS

KANT-SLAM HYDRAULIC GATE CLOSER

Item No.	Description	CASE QTY	LOOSE	24 EACH
----------	-------------	----------	-------	---------

HDGC*	KANT-SLAM Hydraulic Gate Closer	24		
-------	---------------------------------	----	--	--

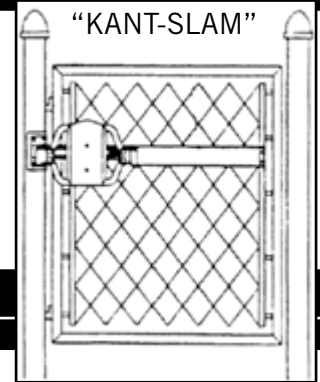

"STA-KLOS" GATE CLOSER

Item No.	Description	CASE QTY	LOOSE	25 EACH
----------	-------------	----------	-------	---------

STA200*	2" x 1-3/8" STA-KLOS Gate Closer	25		
---------	----------------------------------	----	--	--

STA250*	2-1/2" x 1-3/8" STA-KLOS Gate Closer	25		
---------	--------------------------------------	----	--	--

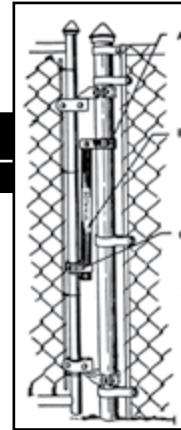

← "STA-KLOS"

RESIDENTIAL LOCKING DEVICE

Item No.	Description	CASE QTY	LOOSE	10 EACH
----------	-------------	----------	-------	---------

RLD*	1-3/8" x 1-3/8" Residential Locking Device	10		
------	--	----	--	--



DROP RODS

Item No.	Description	CASE QTY	LOOSE	25 EACH
----------	-------------	----------	-------	---------

RDR	Residential Drop Rod	25		
-----	----------------------	----	--	--

PFH138*	1-3/8" (P/S Frame Hinge) Drop Rod Guide	100		
---------	---	-----	--	--



SCROLLS

Item No.	Description	CASE QTY	LOOSE	50 EACH
----------	-------------	----------	-------	---------

SCR18	18" Scroll	50		
-------	------------	----	--	--



* = COMBINE 10 CASES OF ANY SYSTEM 21 OR GALV. CHAIN LINK FITTINGS WITH AN ASTERISK FOR A 20% DISCOUNT

GALVANIZED CHAIN LINK FITTINGS



GATE CLIPS

Item No.	Description	CASE QTY	LOOSE	CASE
GC138*	1-3/8" Gate Clip	250		



ALUMINUM GATE CORNERS

Item No.	Description	CASE QTY	LOOSE	100 EACH
AGC138*	1-3/8" Aluminum Gate Corner	100		



STEEL GATE CORNERS

Item No.	Description	CASE QTY	LOOSE	50 EACH
SGC158*	1-5/8" Steel Gate Corner	50		



GATE CENTER STOP

Item No.	Description	CASE QTY	LOOSE	10 EACH
GCS*	Gate Center Stop	10		

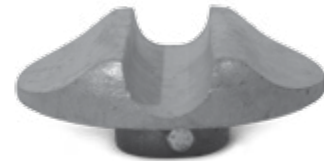

GATE HOLD BACK

Item No.	Description	CASE QTY	LOOSE	25 EACH
GHB*	Gate Hold Back	25		



* = COMBINE 10 CASES OF ANY SYSTEM 21 OR GALV. CHAIN LINK FITTINGS WITH AN ASTERISK FOR A 20% DISCOUNT

GALVANIZED CHAIN LINK FITTINGS



INDUSTRIAL HINGES - MALLEABLE - 180 (1-5/8" or 2" Frame)

Item No.	Description	CASE QTY	LOOSE	12 EACH
IOH250*	2-1/2" x 2" (or 1-5/8") Industrial Offset Hinge	12		
IOH300*	3" x 2" (or 1-5/8") Industrial Offset Hinge	12		
IOH400*	4" x 2" (or 1-5/8") Industrial Offset Hinge	12		
IOH658*	6-5/8" x 2" (or 1-5/8") Industrial Offset Hinge	12		



INDUSTRIAL BOX HINGES MALLEABLE (1-5/8" or 2" Frame)

Item No.	Description	CASE QTY	LOOSE	12 EACH
IBH250*	2-1/2" x 2" (or 1-5/8") Industrial Box Hinge	12		
IBH300*	3" x 2" (or 1-5/8") Industrial Box Hinge	12		
IBH350*	3-1/2" x 2" (or 1-5/8") Industrial Box Hinge	12		
IBH400*	4" x 2" (or 1-5/8") Industrial Box Hinge	12		
IBH658*	6-5/8" x 2" (or 1-5/8") Industrial Box Hinge	12		
IBH858*	8-5/8" x 2" (or 1-5/8") Industrial Box Hinge	12		
180ATT*	180-Degree Box Hinge Adaptor	24		

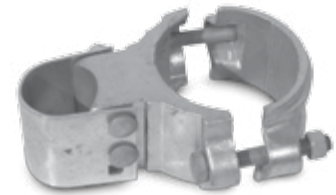

SWING GATE WHEELS

Item No.	Description	CASE QTY	LOOSE	10 EACH
FEGR*	Front End Ground Roller	10		
SGRCL*	Swing Gate Roller - Chain Link	10		
SGRW*	Swing Gate Roller - Wood	10		
SGRSL*	Swing Gate Roller - Spring Loaded	10		



INDUSTRIAL LOCKING DEVICE - PRESSED STEEL - 3 GUIDES

Item No.	Description	CASE QTY	LOOSE	20 EACH
PILD*	Industrial Locking Device - Pressed Steel 2" (or 1-5/8")	20		



INDUSTRIAL LOCKING DEVICE

Item No.	Description	CASE QTY	EACH LOOSE	PER 100
ILD*	Industrial Locking Device	24		

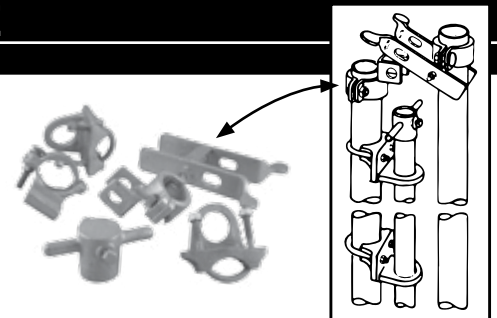

* = COMBINE 10 CASES OF ANY SYSTEM 21 OR GALV. CHAIN LINK FITTINGS WITH AN ASTERISK FOR A 20% DISCOUNT

GALVANIZED CHAIN LINK FITTINGS



GALVANIZED TENSION BARS

Item No.	Description	EACH	1 BUNDLE EACH (25)	4 BUNDLE EACH (100)	MASTER BUNDLES
TB3	3/16" x 5/8" x 34" Galvanized Tension Bar				
TB42	3/16" x 5/8" x 40" Galvanized Tension Bar				
TB4	3/16" x 5/8" x 46" Galvanized Tension Bar				
TB5	3/16" x 5/8" x 58" Galvanized Tension Bar				
TB6	3/16" x 5/8" x 70" Galvanized Tension Bar				
TBH6	3/16" x 3/4" x 70" Galvanized Tension Bar				
TBH7	3/16" x 3/4" x 82" Galvanized Tension Bar				
TBH8	3/16" x 3/4" x 94" Galvanized Tension Bar				
TBH10	3/16" x 3/4" x 118" Galvanized Tension Bar				
TBH12	3/16" x 3/4" x 142" Galvanized Tension Bar				
TBL12	3/16" x 3/8" x 142" Galvanized Tension Bar				
KR12	5/16" x 140" Kennel Rod				



TRUSS RODS

Item No.	Description	LOOSE	1 BUNDLE EACH (25)	4 BUNDLE EACH (100)
TRA	3/8" x 11' Truss Rod with Nut (Available in System21 colors as well)			
TRT	Truss Rod Tightener (Available in System21 colors as well)			



HOG RINGS

Item No.	Description	LOOSE	1 BUNDLE EACH (25)	4 BUNDLE EACH (100)
AHR	Hog Rings - Aluminum			
GHR	Hog Rings - Galvanized			



* = COMBINE 10 CASES OF ANY SYSTEM 21 OR GALV. CHAIN LINK FITTINGS WITH AN ASTERISK FOR A 20% DISCOUNT

GALVANIZED CHAIN LINK FITTINGS

BARB WIRE

Item No.	Description	CASE QTY	PER ROLL	PALLETS
BW15	15½-Gauge 4-PT Class 3 Galvanized 1320' Spool Barb Wire	27		
BW3	12½-Gauge 4-PT Class 3 Galvanized 1320' Spool Barb Wire	27		
BWAZ	12½-Gauge Aluminized 1000' Spool Barb Wire	CALL		

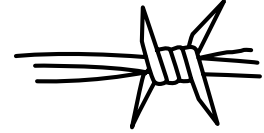

1-PIECE STEEL BARB ARM

Item No.	Description	CASE QTY	LOOSE	25 each
BA158*	1-5/8" x 1-5/8" - 1-Piece Steel Barb Wire Arm	25		
BA215*	2" x 1-5/8" - 1-Piece Steel Barb Wire Arm	25		
BA255*	2-1/2" x 1-5/8" - 1-Piece Steel Barb Wire Arm	25		
BA315*	3" x 1-5/8" - 1-Piece Steel Barb Wire Arm	25		



1-PIECE STEEL BARB V-ARM

Item No.	Description	CASE QTY	LOOSE	30 each
VA250*	2-1/2" x 1-5/8" - 1-Piece Steel V-Arm	30		



MALLEABLE CORNER BARB ARM

Item No.	Description	CASE QTY	LOOSE	30 each
CBA250*	2-1/2" Malleable Corner Barb Wire Arm 3-Strand	30		
CBA300*	3" Malleable Corner Barb Wire Arm 3-Strand	30		
CBA400*	4" Malleable Corner Barb Wire Arm 3-Strand	30		



MALLEABLE CORNER V-ARMS

Item No.	Description	CASE QTY	LOOSE	CASE
CBA6250*	2-1/2" Malleable Corner Barb Wire Arm 6-Strand	30		
CBA6300*	3" Malleable Corner Barb Wire Arm 6-Strand	30		
CBA6400*	4" Malleable Corner Barb Wire Arm 6-Strand	30		



* = COMBINE 10 CASES OF ANY SYSTEM 21 OR GALV. CHAIN LINK FITTINGS WITH AN ASTERISK FOR A 20% DISCOUNT

GALVANIZED CHAIN LINK FITTINGS



STEEL BARB ARM BLADE 3 - Wire Z-Slot

Item No.	Description	CASE QTY	LOOSE	40 each
BABL*	Steel Barb Arm Blade - Only	40		



STEEL BARB WIRE ARM BASE

Item No.	Description	CASE QTY	LOOSE	50 each
GBAB158	1-5/8" x 1-5/8" Steel Barb Arm Base	50		
GBAB215*	2" x 1-5/8" Steel Barb Arm Base	50		
GBAB255*	2-1/2" x 1-5/8" Steel Barb Arm Base	50		
GBAB315*	3" x 1-5/8" Steel Barb Arm Base	50		
GBAB355	3-1/2" x 1-5/8" Steel Barb Arm Base	50		
GBAB415*	4" x 1-5/8" Steel Barb Arm Base	50		



CANTILEVER BARB ARM

Item No.	Description	CASE QTY	EACH LOOSE	CASE
BAC	Cantilever Barb Wire Arm - Bolt On	24		



QUICK SET ANCHORING CEMENT

Item No.	Description	CASE QTY	LOOSE	CASE
EQS	Anchoring Cement - Eastern Quick Set	36		



* = COMBINE 10 CASES OF ANY SYSTEM 21 OR GALV. CHAIN LINK FITTINGS WITH AN ASTERISK FOR A 20% DISCOUNT

GALVANIZED CHAIN LINK FITTINGS



FULCRUM LATCHES

Item No.	Description	CASE QTY	LOOSE	10 EACH
FUL250*	2-1/2" x 2" (or 1-5/8") Fulcrum Latch - Single Leaf	10		
FUL300*	3" x 2" (or 1-5/8") Fulcrum Latch - Single Leaf	10		
FUL400*	4" x 2" (or 1-5/8") Fulcrum Latch - Single Leaf	10		
FUL200*	2" (or 1-5/8") Fulcrum Latch - Double Leaf	10		



HI SECURITY DOUBLE GATE LATCH

Item No.	Description	CASE QTY	LOOSE	15 EACH
HSGL*	2" (or 1-5/8") Hi Security Double Gate Latch	15		



CANTILEVER LATCH - SINGLE LEAF

Item No.	Description	CASE QTY	LOOSE	CASE
CL300*	3" x 2" Cantilever Latch - Single Leaf	10		
CL400*	4" x 2" Cantilever Latch - Single Leaf	10		



CANTILEVER LATCH DOUBLE LEAF

Item No.	Description	CASE QTY	LOOSE	CASE
RGL-000*	2" x 2" Cantilever Latch - Double Leaf			



CANTILEVER ROLLER

Item No.	Description	CASE QTY	LOOSE	10 EACH
CR400N*	4" x 2-1/2" (or 2") Cantilever Roller NYLON	10		
CR300*	3" x 2-1/2" (or 2") Cantilever Roller	10		
CR400*	4" x 2-1/2" (or 2") Cantilever Roller	10		
CR658*	6-5/8" x 2-1/2" (or 2") Cantilever Roller	10		



CANTILEVER ROLLER GUARD (Must Order Guard With Each Roller)

Item No.	Description	CASE QTY	LOOSE	10 EACH
CRGUARD*	Cantilever Roller Guard (Must Order With Rollers)	10		



* = COMBINE 10 CASES OF ANY SYSTEM 21 OR GALV. CHAIN LINK FITTINGS WITH AN ASTERISK FOR A 20% DISCOUNT

MISCELLANEOUS

COIL SPRING WIRE - Available in Black (BK), Brown (BR), Eastern Green (EG)

Item No.	Description	LOOSE	PER 100
----------	-------------	-------	---------

CW6-	6-Gauge x 1000' Vinyl Coil Spring Tension Wire		
------	--	--	--

CW9-	Coil Straight Wire		
------	--------------------	--	--

GSW7	7-Gauge Galvanized Coil Spring Tension Wire		
------	---	--	--

AZSW7	7-Gauge Aluminized Coil Spring Tension Wire		
-------	---	--	--



GALVANIZED CHAIN

Item No.	Description	PER FOOT	PER 250 FEET
----------	-------------	----------	--------------

CHAIN	3/16 HD Galvanized Chain		
-------	--------------------------	--	--



BACKSTOP "EL" - BASEBALL BACKSTOP ADAPTOR

Item No.	Description	LOOSE	PER 100
----------	-------------	-------	---------

BSL*	Back Stop "El"		
------	----------------	--	--



MALLEABLE FLOOR FLANGE

Item No.	Description	LOOSE	PER 100
----------	-------------	-------	---------

MFF200*	2" Malleable Floor Flange		
---------	---------------------------	--	--

MFF250*	2-1/2" Malleable Floor Flange		
---------	-------------------------------	--	--

MFF300*	3" Malleable Floor Flange		
---------	---------------------------	--	--



FLOOR FLANGE - STEEL WELDABLE (Other Sizes in Stock)

Item No.	Description	LOOSE	PER 100
----------	-------------	-------	---------

FF4414*	4" x 4" x 1/4" Floor Flange Plate		
---------	-----------------------------------	--	--

FF6614*	6" x 6" x 1/4" Floor Flange Plate		
---------	-----------------------------------	--	--

FF6638*	6" x 6" x 3/8" Floor Flange Plate		
---------	-----------------------------------	--	--

FF8814*	8" x 8" x 1/4" Floor Flange Plate		
---------	-----------------------------------	--	--

FF8838*	8" x 8" x 3/8" Floor Flange Plate		
---------	-----------------------------------	--	--



* = COMBINE 10 CASES OF ANY SYSTEM 21 OR GALV. CHAIN LINK FITTINGS WITH AN ASTERISK FOR A 20% DISCOUNT

OVERHEAD SLIDE GATE SYSTEMS

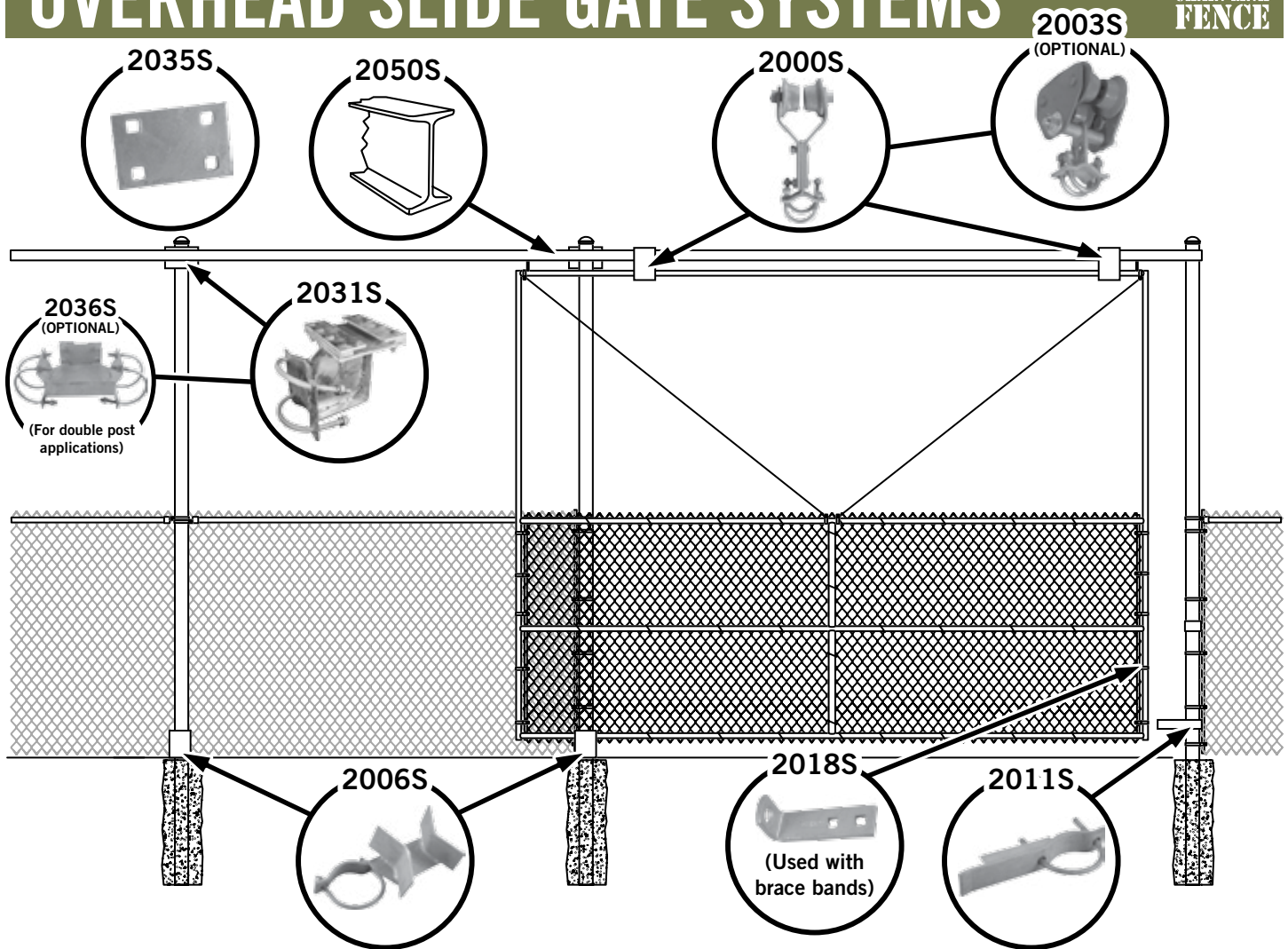

BEAM HANGER ASSEMBLY

Item No.	Description	Wt. Each	LOOSE
2031S	Beam Hanger for 4" Post	12.250#	
2036S	Beam Hanger for Double 4" Post	15.000#	
2035S	Beam Splice Plate	1.000#	
2000S	Trolley Wheel and Assembly	8.000#	
2003S	4-Wheel Double Trolley	8.000#	

GUIDE ASSEMBLY

Item No.	Description	Wt. Each	LOOSE
2006S	4" Guide Assembly	7.000#	

STOP ASSEMBLY

Item No.	Description	Wt. Each	LOOSE
2011S	4" Stop Assembly	3.000#	

LOCKING STOP ASSEMBLY

Item No.	Description	Wt. Each	LOOSE
2018S	Locking Bracket	.500#	





I-BEAM OVERHEAD TRACK

Item No.	Description	Wt. Each	LOOSE
2050S	5" Galvanized x 20' I-Beam Overhead Track	12.500#	

OVERHEAD SLIDE GATE SYSTEMS

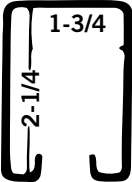

SLIDING GATE TRACK SYSTEMS - LIGHT WEIGHT GATES GALVANIZED

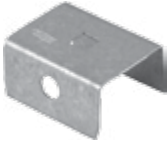
Item No.	Description	LOOSE	PER FOOT		
5116-10	10' Sliding Gate Track				
1050T	Sliding Gate Truck w/4-1/2" Bolt				
51F	Sliding Gate Single Bracket				
51G	Sliding Gate Single Splice Bracket				
51HS	Sliding Gate Double Splice Bracket				
51ED	Sliding Gate Track End Cap				

Heavier Rail and Specialty Items Available Upon Request
"GATE PRICES – CALL FOR QUOTE"

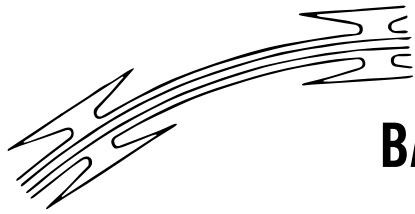

RAZOR RIBBON BARBED OBSTACLE TAPES



RAZOR RIBBON - BARBED OBSTACLE TAPES

Item No.	Description	1-9 ROLLS	10-25 ROLLS	26-50 ROLLS
RR18-GALV	18" Diameter 50' Roll Galvanized Barbed Obstacle Tape			
RR18	18" Diameter 50' Roll Stainless Steel Barbed Obstacle Tape			

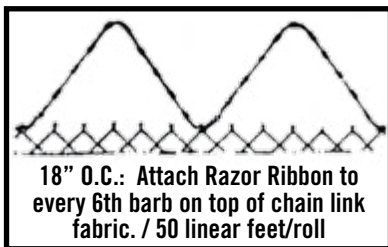

Recommended for general commercial security purposes.

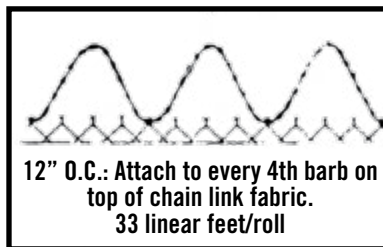

Recommended for commercial facilities which require high security.

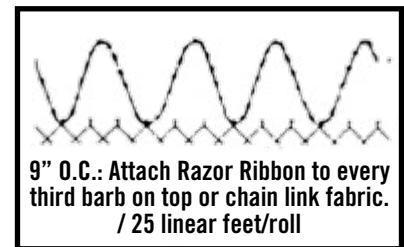

Recommended for correctional and other highly sensitive areas.

RAZOR RIBBON TOOLS

Item No.	Description	LOOSE
FTT	Automatic Tie Twisting Tool	

RAZOR RIBBON TIES

Item No.	Description	BAG 100 PER	BUNDLE 50 BAGS
SFT16	Steel 16-Gauge x 8" Double Loop Tie Galvanized		
RRTIESS	18-Gauge x 8" Stainless Steel Double Loop Tie		

Barbed tape products are not designed or intended for residential application. These products are not to be used as ground barriers on commercial applications. Ground barriers should only be used in locations such as military installations and correctional facilities. The manufacturer recommends that all barbed tape be installed on existing fences or walls not less than 7 ft. above ground level. This material shall also be installed in such a manner as to present a clear and highly visible element of danger, and to avoid any and all contact with pedestrian traffic. Do not attempt to conceal, disguise, or transform these products under any condition or application. Eastern disclaims legal accountability from any and all damages, claims, and legal actions as the result of injury caused by improper installation or failure to comply with the relevant laws, codes, and ordinances applicable to these products. Be certain to check all local regulations governing security fencing products, and specific zoning requirements and restrictions as they may apply. The use of protective gloves and proper installation tools by experienced personnel is recommended.

SPEED RAIL FITTINGS (ALUMINUM)



OTHER SIZES AND FITTING STYLES AVAILABLE - PLEASE CALL FOR MORE INFO

SPEED RAIL FITTINGS ALUMINUM

Description	1-3/8" CODE.	Each	1-5/8" Code	Each	2" Code	Each	2-1/2" Code	Each
#3 - Elbow	SR1383		SR1583		SR2003		SR2503	
#5 - Tee	SR1385		SR1585		SR2005		SR2505	
#7 - Cross	SR1387		SR1587		SR2007		SR2507	
#9 - Side Outlet Ell.	SR1389		SR1589		SR2009		SR2509	
#11 - Side Outlet Tee	SR13811		SR15811		SR20011		SR25011	
#13 - Side Outlet Cross	SR13813		SR15813		SR20013			
#17 - Adj. Tee	SR13817		SR15817		SR20017			
#19 - Adjustable Cross	SR13819		SR15819		SR20019			
#23 - Adjustable Tee/Cross	SR13823		SR15823		SR20023			
#41 - Adjustable Wall Flange	SR13841		SR15841		SR20041			
#47 - Rect. Base Flange	SR13847		SR15847		SR20047		SR25047	
#60 - Plug (for use w/ Sched. 40 Pipe)	SR13860		SR15860		SR20060		SR25060	
#62 - Plug (for use w/ Sched. 40 Pipe)	SR13862		SR15862		SR20062			

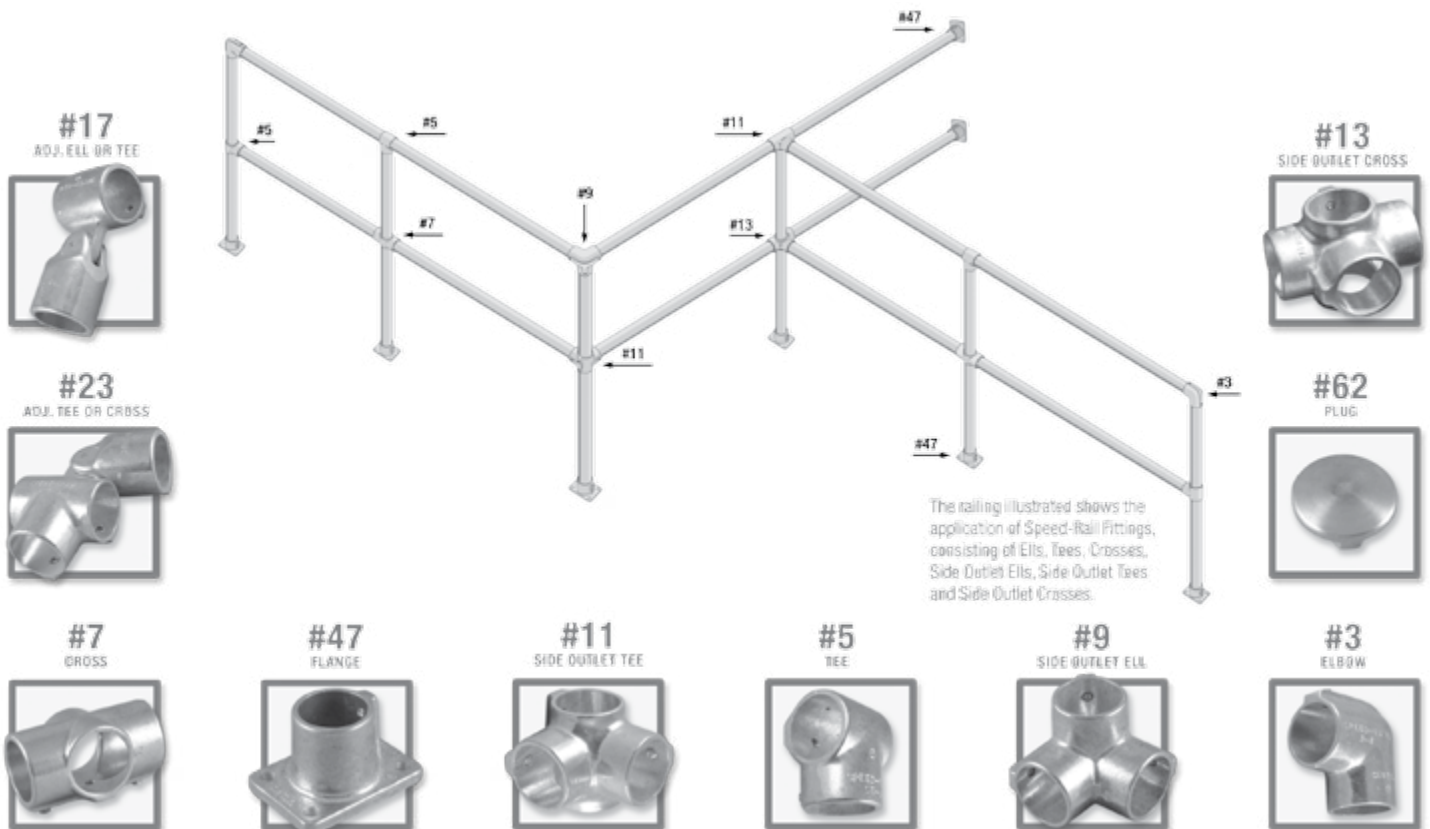

GALVANIZED SPEED-RAIL FITTINGS



EASTERN GALVANIZED SPEED-RAIL FITTINGS IMAGES



10



12

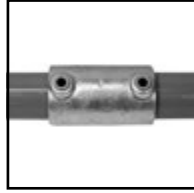

14



15



16



17



18



19



20



21



25



26



29



30



35



40



45



46



50



51



52



58



60



61



62



64



66



68



70



84



114



350



351



515

GALVANIZED SPEED-RAIL FITTINGS



EASTERN GALVANIZED SPEED-RAIL FITTINGS

Item	1-3/8" Item No.	Each	1-5/8" Item No.	Each	2" Item No.	Each	2-1/2" Item No.	Each
#10 Single Socket Tee	GR13810		GR15810		GR20010		GR25010	
#12 45-Degree Single Socket Tee	GR13812		GR15812		GR20012			
#14 Straight Coupling	GR13814		GR15814		GR20014		GR25014	
#15 90-Degree Elbow	GR13815		GR15815		GR20015		GR25015	
#16 Clamp-on Tee	GR13816		GR15816		GR20016		GR25016	
#17 Clamp-on Crossover	GR13817		GR15817		GR20017		GR25017	
#18 Internal Coupling	GR13818		GR15818		GR20018			
#19 Adjustable Side Outlet Tee	GR13819		GR15819		GR20019		GR25019	
#20 Side Outlet Elbow	GR13820		GR15820		GR20020		GR25020	
#21 90-Degree Side Outlet Tee	GR13821		GR15821		GR20021		GR25021	
#25 3-Socket Tee	GR13825		GR15825		GR20025		GR25025	
#26 2-Socket Cross	GR13826		GR15826		GR20026		GR25026	
#29 30-60-Degree Single Socket Tee	GR13829		GR15829		GR20029			
#30 30-45-Degree Adjustable Cross	GR13830		GR15830		GR20030			
#35 3-Socket Cross	GR13835		GR15835		GR20035		GR25035	
#40 4-Socket Cross	GR13840		GR15840		GR20040		GR25040	
#45 Crossover	GR13845		GR15845		GR20045		GR25045	
#46 Combo Socket Tee	GR13846		GR15846		GR20046		GR25046	
#50 Single Swivel Socket	GR13850		GR15850		GR20050		GR25050	
#51 Double Swivel Socket	GR13851		GR15851		GR20051		GR25051	
#52 Corner Swivel Socket	GR13852		GR15852		GR20052			
#58 Swivel Flange	GR13858		GR15858		GR20058		GR25058	
#60 Extra Heavy Round Flange	GR13860		GR15860		GR20060			
#61 Round Flange	GR13861		GR15861		GR20061		GR25061	
#62 Railing Flange	GR13862		GR15862		GR20062		GR25062	
#64 Standard Vertical Railing Base	GR13864		GR15864		GR20064			
#66 Ground Socket	GR13866		GR15866		GR20066			
#68 Wall Flange	GR13868		GR15868		GR20068			
#70 Rail Support	GR13870		GR15870		GR20070			
#84 Malleable Drive Plug	GR13884		GR15884		GR20084		GR25084	
#114 Swiveltee Internal	GR138114		GR158114		GR200114			
#350 Eaves Fitting					GR200350			
#351 Ridge Fitting					GR200351			
#515 2-Side Internal Elbow			GR158515					

ROLLING GATE KITS

ROLLING GATE KITS

Item No.	Description	LOOSE
H-128KIT	Rolling Gate Kit	

Kit Includes:

- 1 Each - #DWC-128 12" wide carrier with 8" wheels (*OPTIONAL pneumatic wheels)
- 1 Each - #RGL-000 Latch (Req. 2 brace bands - not included)
- 6 Each - #UTB-278 Universal Track Bracket (2", 2-1/2" or 3" O.D.) - (*OPTIONAL for 4" Post RTB-000)
- 2 Each - #SPW-000 Track wheels
- 2 Each - #PWB-158 Wheel brackets for 1-5/8" frame
- 2 Each - #PWB-178 Wheel brackets for 2" frame

NOTE: "BEVELED BRACE BANDS" are recommended wherever attaching bands are required.

FRAME CONFIGURATION

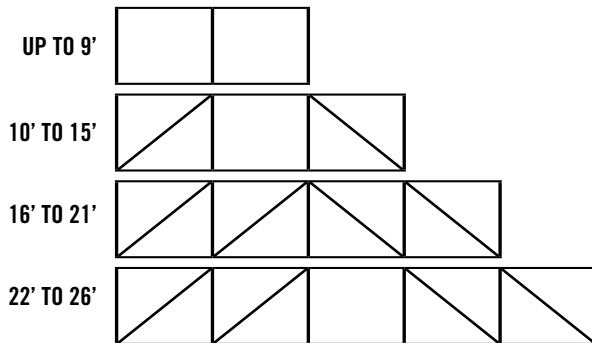

ROLLING GATE HARDWARE

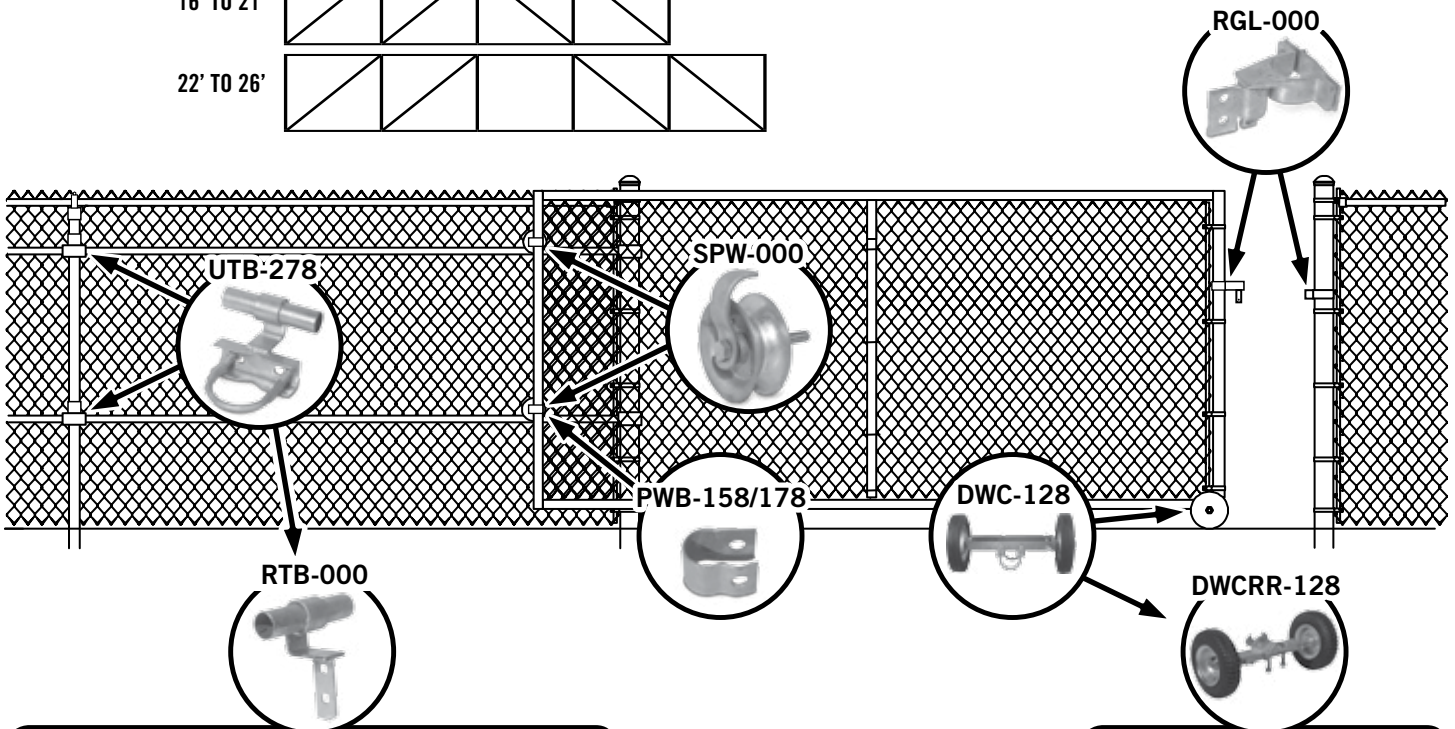







*OPTIONAL - To be used with 4" pipe with brace bands

*OPTIONAL - Pneumatic wheels

ROLLING GATE HARDWARE

ROLLING GATE HARDWARE

Item No.	Description	CASE QTY	LOOSE	CASE
DWC-128	12" Wide Carrier with 8" Wheels			
DWCRR-128	12" Wide Carrier with 8" Pneumatic Rut Runner Wheels			
RGL-000	Rolling Gate latch - Lockable			
UTB-278	2-1/2" or 3" Universal Track Bracket			
RTB-000	Residential Track Bracket			
SPW-000	Safety Track Wheels			
PWB-158	1-5/8" Pipe Wheel Bracket			
PWB-178	2" Pipe Wheel Bracket			

GALVANIZED RESIDENTIAL GATE FRAMES

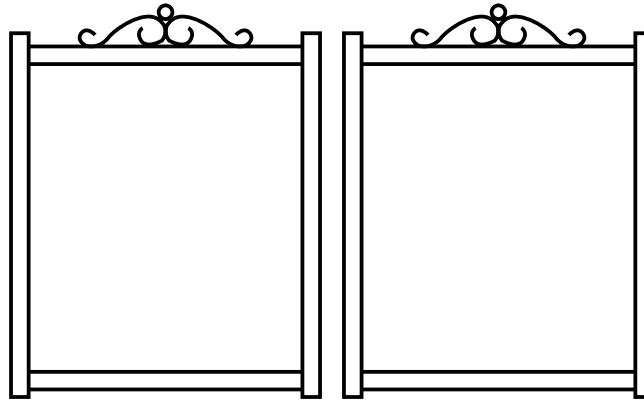

SPEC. GALVANIZED FRAMEWORK - RESIDENTIAL GRADE

Welded fabrication using residential 17Ga- .055 domestic pipe | Frames below are unfilled

Item No.	Nominal O.D.	Description	Opening	Height	Loose Each
GF34	1-3/8"	Galvanized Frame Single Gate	36"	4'	
GF35	1-3/8"	Galvanized Frame Single Gate	36"	5'	
GF36	1-3/8"	Galvanized Frame Single Gate	36"	6'	
GF424	1-3/8"	Galvanized Frame Single Gate	42"	4'	
GF425	1-3/8"	Galvanized Frame Single Gate	42"	5'	
GF426	1-3/8"	Galvanized Frame Single Gate	42"	6'	
GF44	1-3/8"	Galvanized Frame Single Gate	48"	4'	
GF45	1-3/8"	Galvanized Frame Single Gate	48"	5'	
GF46	1-3/8"	Galvanized Frame Single Gate	48"	6'	
GF54	1-3/8"	Galvanized Frame Single Gate	60"	4'	
GF55	1-3/8"	Galvanized Frame Single Gate	60"	5'	
GF56	1-3/8"	Galvanized Frame Single Gate	60"	6'	
DD84	1-3/8"	Galvanized Double Drive	96"	4'	
DD85	1-3/8"	Galvanized Double Drive	96"	5'	
DD86	1-3/8"	Galvanized Double Drive	96"	6'	
DD104	1-3/8"	Galvanized Double Drive	120"	4'	
DD105	1-3/8"	Galvanized Double Drive	120"	5'	
DD106	1-3/8"	Galvanized Double Drive	120"	6'	
DD124	1-3/8"	Galvanized Double Drive	144"	4'	
DD125	1-3/8"	Galvanized Double Drive	144"	5'	
DD126	1-3/8"	Galvanized Double Drive	144"	6'	

***** FILLED FRAMES ALSO AVAILABLE *****

Note: Please call to order filled frames

Scrolls are fastened on 4' high gates ONLY. 5' high and up are center braced.

Non-stock sizes available upon request - Call for \$\$

GALVANIZED INDUSTRIAL WALK GATE FRAMES



SPEC INDUSTRIAL FRAMES: GALVANIZED ONLY

Welded Fabrication using SS20 0.85 wall (for 1-5/8) and SS20 0.90 wall (for 2" frames)
Frames only — No fabric included

SINGLEWALK GATES

Item #	Frame Size	Opening	Height	Each Loose
IG158-34	1-5/8"	3' OPENING	4' High	
IG158-35	1-5/8"	3' OPENING	5' High	
IG158-36	1-5/8"	3' OPENING	6' High	
IG158-37	1-5/8"	3' OPENING	7' High	
IG158-38	1-5/8"	3' OPENING	8' High	
IG158-44	1-5/8"	4' OPENING	4' High	
IG158-45	1-5/8"	4' OPENING	5' High	
IG158-46	1-5/8"	4' OPENING	6' High	
IG158-47	1-5/8"	4' OPENING	7' High	
IG158-48	1-5/8"	4' OPENING	8' High	
IG158-54	1-5/8"	5' OPENING	4' High	
IG158-55	1-5/8"	5' OPENING	5' High	
IG158-56	1-5/8"	5' OPENING	6' High	
IG158-57	1-5/8"	5' OPENING	7' High	
IG158-58	1-5/8"	5' OPENING	8' High	
IG200-36	2"	3' OPENING	6' High	
IG200-37	2"	3' OPENING	7' High	
IG200-38	2"	3' OPENING	8' High	
IG200-46	2"	4' OPENING	6' High	
IG200-47	2"	4' OPENING	7' High	
IG200-48	2"	4' OPENING	8' High	
IG200-56	2"	5' OPENING	6' High	
IG200-57	2"	5' OPENING	7' High	
IG200-58	2"	5' OPENING	8' High	

FRAME ONLY

FRAME CONFIGURATIONS

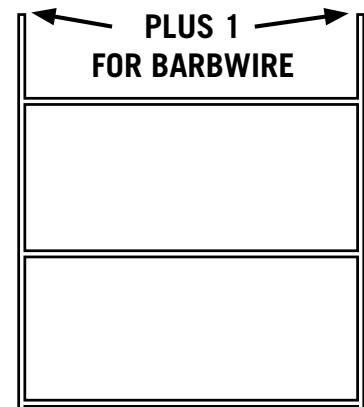
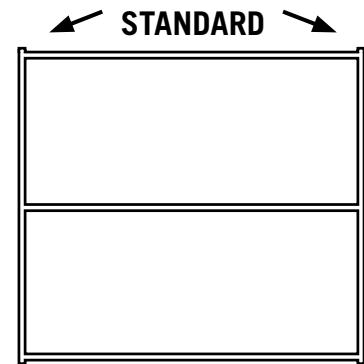

FILLED FRAME ALSO AVAILABLE

GALVANIZED INDUSTRIAL DOUBLE DRIVE FRAMES



SPEC INDUSTRIAL FRAMES: GALVANIZED ONLY

Welded Fabrication using SS20 0.85 wall (for 1-5/8") and SS20 0.90 wall (for 2" frames)
 Frames only — No fabric included

DOUBLE DRIVE GATES

Item #	Frame Size	Opening	Height	Each Loose
IG158-104	1-5/8"	10' OPENING	4' High	
IG158-105	1-5/8"	10' OPENING	5' High	
IG158-106	1-5/8"	10' OPENING	6' High	
IG158-107	1-5/8"	10' OPENING	7' High	
IG158-108	1-5/8"	10' OPENING	8' High	
IG158-124	1-5/8"	12' OPENING	4' High	
IG158-125	1-5/8"	12' OPENING	5' High	
IG158-126	1-5/8"	12' OPENING	6' High	
IG158-127	1-5/8"	12' OPENING	7' High	
IG158-128	1-5/8"	12' OPENING	8' High	
IG158-144	1-5/8"	14' OPENING	4' High	
IG158-145	1-5/8"	14' OPENING	5' High	
IG158-146	1-5/8"	14' OPENING	6' High	
IG158-147	1-5/8"	14' OPENING	7' High	
IG158-148	1-5/8"	14' OPENING	8' High	
IG158-164	1-5/8"	16' OPENING	4' High	
IG158-165	1-5/8"	16' OPENING	5' High	
IG158-166	1-5/8"	16' OPENING	6' High	
IG158-167	1-5/8"	16' OPENING	7' High	
IG158-168	1-5/8"	16' OPENING	8' High	
IG158-184	1-5/8"	18' OPENING	4' High	
IG158-185	1-5/8"	18' OPENING	5' High	
IG158-186	1-5/8"	18' OPENING	6' High	
IG158-187	1-5/8"	18' OPENING	7' High	
IG158-188	1-5/8"	18' OPENING	8' High	
IG200-106	2"	10' OPENING	6' High	
IG200-107	2"	10' OPENING	7' High	
IG200-108	2"	10' OPENING	8' High	
IG200-126	2"	12' OPENING	6' High	
IG200-127	2"	12' OPENING	7' High	
IG200-128	2"	12' OPENING	8' High	
IG200-146	2"	14' OPENING	6' High	
IG200-147	2"	14' OPENING	7' High	
IG200-148	2"	14' OPENING	8' High	
IG200-166	2"	16' OPENING	6' High	
IG200-167	2"	16' OPENING	7' High	
IG200-168	2"	16' OPENING	8' High	
IG200-186	2"	18' OPENING	6' High	
IG200-187	2"	18' OPENING	7' High	
IG200-188	2"	18' OPENING	8' High	
IG200-226	2"	22' OPENING	6' High	
IG200-227	2"	22' OPENING	7' High	
IG200-228	2"	22' OPENING	8' High	
IG200-266	2"	26' OPENING	6' High	
IG200-267	2"	26' OPENING	7' High	
IG200-268	2"	26' OPENING	8' High	
IG200-306	2"	30' OPENING	6' High	
IG200-307	2"	30' OPENING	7' High	
IG200-308	2"	30' OPENING	8' High	

FRAME ONLY

FRAME CONFIGURATIONS

Up to 10' Wide
 (Price Includes 2 leaves)

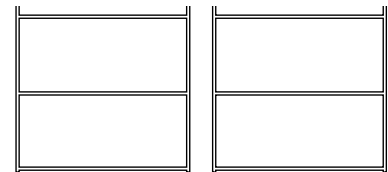

12' to 24' Wide
 (Price Includes 2 leaves)

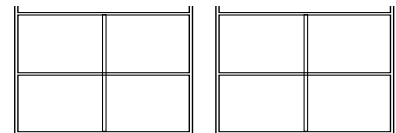

26' to 30' Wide
 (Price Includes 2 leaves)
 ("K" Brace Recommended)

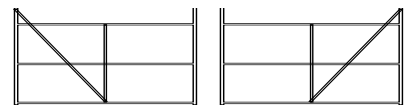

SWING GATE RECOMMENDED POST SIZES		
	MAXIMUM SINGLE	MAXIMUM DOUBLE
3" O.D.	6'	12'
4" O.D.	13'	26'
6-5/8" O.D.	18'	36'
8-5/8" O.D.	18' UP	36' UP

FILLED FRAME ALSO AVAILABLE

BARRIER GATES

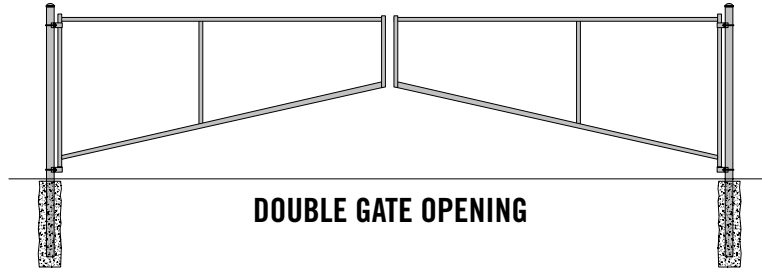
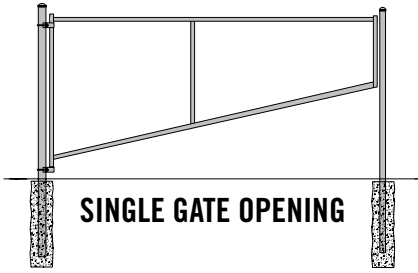

Easy to install Eastern Barrier Gates are great for using with commercial or residential applications. They are a perfect way to restrict vehicular access to a property. Eastern Barrier Gates can be installed in single swing or double swing configurations.

Color Coated System21 Gates Available Upon Request | Notched and/or Hammered Joints | Welded After Galvanizing
Seams Painted With Welder's Paint After Welding | Vertical Bracing Varies Per Gate Width
Compatible With a Variety of Gate Hinges and Latches | Custom Designs Available Upon Request (Customers Must Prepare Own Drawing)

1-5/8" FRAME SIZE

Item #	Frame Size	Opening	Height	Each Loose
BG158-6	1-5/8"	6' SINGLE GATE OPENING	4' High - 2' High	
BG158-8	1-5/8"	8' SINGLE GATE OPENING	4' High - 2' High	
BG158-10	1-5/8"	10' DOUBLE GATE OPENING	4' High - 2' High	
BG158-10SF	1-5/8"	10' SINGLE GATE OPENING	4' High - 2' High	
BG158-11	1-5/8"	11' DOUBLE GATE OPENING	4' High - 2' High	
BG158-12	1-5/8"	12' DOUBLE GATE OPENING	4' High - 2' High	
BG158-12SF	1-5/8"	12' SINGLE GATE OPENING	4' High - 2' High	
BG158-13SF	1-5/8"	13' SINGLE GATE OPENING	4' High - 2' High	
BG158-14	1-5/8"	14' DOUBLE GATE OPENING	4' High - 2' High	
BG158-16	1-5/8"	16' DOUBLE GATE OPENING	4' High - 2' High	
BG158-16SF	1-5/8"	16' SINGLE GATE OPENING	4' High - 2' High	
BG158-17	1-5/8"	17' DOUBLE GATE OPENING	4' High - 2' High	
BG158-17SF	1-5/8"	17' SINGLE GATE OPENING	4' High - 2' High	
BG158-18	1-5/8"	18' DOUBLE GATE OPENING	4' High - 2' High	
BG158-18SF	1-5/8"	18' SINGLE GATE OPENING	4' High - 2' High	
BG158-20	1-5/8"	20' DOUBLE GATE OPENING	4' High - 2' High	
BG158-22	1-5/8"	22' DOUBLE GATE OPENING	4' High - 2' High	
BG158-24	1-5/8"	24' DOUBLE GATE OPENING	4' High - 2' High	
BG158-24SF	1-5/8"	24' SINGLE GATE OPENING	4' High - 2' High	
BG158-25	1-5/8"	25' DOUBLE GATE OPENING	4' High - 2' High	
BG158-26	1-5/8"	26' DOUBLE GATE OPENING	4' High - 2' High	
BG158-28	1-5/8"	28' DOUBLE GATE OPENING	4' High - 2' High	
BG158-30	1-5/8"	30' DOUBLE GATE OPENING	4' High - 2' High	
BG158-32	1-5/8"	32' DOUBLE GATE OPENING	4' High - 2' High	
BG158-44	1-5/8"	44' DOUBLE GATE OPENING	4' High - 2' High	

2" FRAME SIZE

Item #	Frame Size	Opening	Height	Each Loose
BG200-6	2"	6' SINGLE GATE OPENING	4' High - 2' High	
BG200-8	2"	8' SINGLE GATE OPENING	4' High - 2' High	
BG200-10	2"	10' DOUBLE GATE OPENING	4' High - 2' High	
BG200-11	2"	11' DOUBLE GATE OPENING	4' High - 2' High	
BG200-12	2"	12' DOUBLE GATE OPENING	4' High - 2' High	
BG200-12SF	2"	12' SINGLE GATE OPENING	4' High - 2' High	
BG200-14	2"	14' DOUBLE GATE OPENING	4' High - 2' High	
BG200-14SF	2"	14' SINGLE GATE OPENING	4' High - 2' High	
BG200-15SF	2"	15' SINGLE GATE OPENING	4' High - 2' High	
BG200-16	2"	16' DOUBLE GATE OPENING	4' High - 2' High	
BG200-16SF	2"	16' SINGLE GATE OPENING	4' High - 2' High	
BG200-18	2"	18' DOUBLE GATE OPENING	4' High - 2' High	
BG200-19SF	2"	19' SINGLE GATE OPENING	4' High - 2' High	
BG200-20	2"	20' DOUBLE GATE OPENING	4' High - 2' High	
BG200-20SF	2"	20' SINGLE GATE OPENING	4' High - 2' High	
BG200-21	2"	21' DOUBLE GATE OPENING	4' High - 2' High	
BG200-22	2"	22' DOUBLE GATE OPENING	4' High - 2' High	
BG200-24	2"	24' DOUBLE GATE OPENING	4' High - 2' High	
BG200-25	2"	25' DOUBLE GATE OPENING	4' High - 2' High	
BG200-26	2"	26' DOUBLE GATE OPENING	4' High - 2' High	
BG200-28	2"	28' DOUBLE GATE OPENING	4' High - 2' High	
BG200-30	2"	30' DOUBLE GATE OPENING	4' High - 2' High	
BG200-31	2"	31' DOUBLE GATE OPENING	4' High - 2' High	
BG200-34	2"	34' DOUBLE GATE OPENING	4' High - 2' High	
BG200-35	2"	35' DOUBLE GATE OPENING	4' High - 2' High	

PEN PALS KENNELS/ENCLOSURES



KENNELS/ENCLOSURES

FRAMES:

1-3/8" O.D. galv. tubing

FABRIC:

2-3/8" mesh, 12½-Gauge Smooth Galvanized Wire

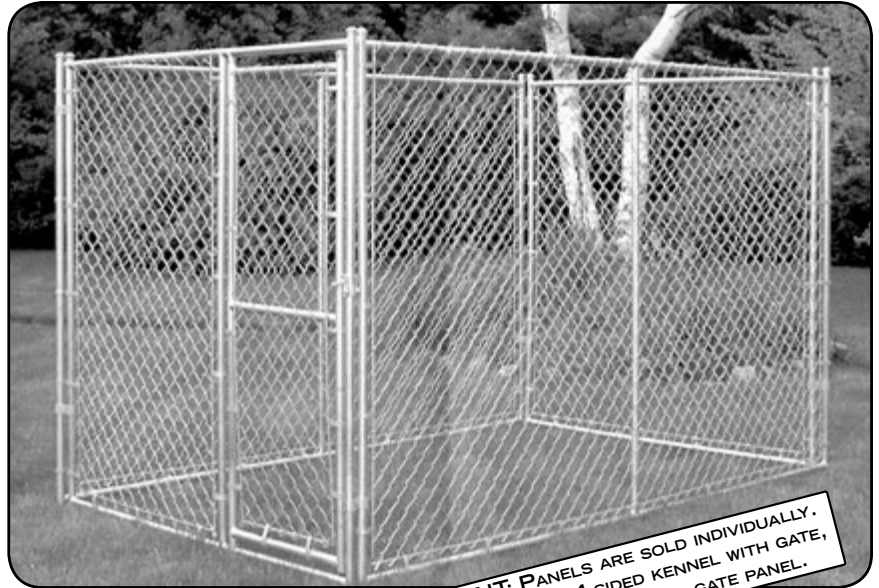

IMPORTANT: PANELS ARE SOLD INDIVIDUALLY. TO CREATE A COMPLETE 4-SIDED KENNEL WITH GATE, ORDER THREE SIDE PANELS AND A GATE PANEL.

PANELS												
	6' HIGH				5' HIGH				4' HIGH			
	SIDE PANEL		GATE PANEL		SIDE PANEL		GATE PANEL		SIDE PANEL		GATE PANEL	
WIDTH	ITEM	COST	ITEM	COST	ITEM	COST	ITEM	COST	ITEM	COST	ITEM	COST
3'	KP36		KGP36		KP35		KGP35		KP34		KGP34	
4'	KP46		KGP46		KP45		KGP45		KP44		KGP44	
5'	KP56		KGP56		KP55		KGP55		KP54		KGP54	
6'	KP66		KGP66		KP65		KGP65		KP64		KGP64	
8'	KP86		KGP86		KP85		KGP85		KP84		KGP84	
10'	KP106		KGP106		KP105		KGP105		KP104		KGP104	
12'	KP126		KGP126		KP125		KGP125		KP124		KGP124	
14'	KP146		KGP146		KP145		KGP145		KP144		KGP144	

IMPORTANT: Panels are sold individually. To create a complete 4-sided kennel with gate, order three side panels and a gate panel.

OPTIONS/ACCESSORIES:

- 9 gauge, 2" mesh, Vinyl-clad fabric Add 15%
- 9 gauge, 2" mesh, Galvanized fabric Add 20%
- Puppy, snow, or hesitation panel Add \$
- Dog house openings Add \$
- ADC138 Alum-Dome Cap (Need 9) \$
- SC138 Saddle Clamp. (Need 8) \$

COMPLETE KENNELS/ENCLOSURES

- 6'H - 6'W - 10'L CALL FOR PRICE
- 6'H - 6'W - 12'L CALL FOR PRICE

INTERNAL SLIDE GATES

SLIDE GATES

CALL FOR QUOTE



One of the industry's most versatile gates, Eastern Slide Gates cover a wide range of applications. From airports, warehouses, and military facilities, to industrial storage yards, housing sites, and even prisons, Eastern Slide Gates are the professional's choice.

Eastern Slide Gates use a unique roller bearing system sealed above in a one piece enclosed track to provide maintenance free performance. With no roller bearings on the ground to trap debris, operation of the gate is always smooth and easy. Added stability and strength are provided by a vertical member securely welded to the one piece track member.

Constructed of a high quality aluminum, Eastern Slide Gates are both light weight and durable. A chain link fabric is secured to the gate frame on all four sides with J-bolts. This makes for a much more stable gate then those secured in conventional ways.

A color coated finish is an added available option to match any color requirement you may have. Eastern's color coated fence option is always the perfect quality touch. If a specialized gate fits the bill, let our custom design team develop the perfect gate for your needs.

Eastern Internal Slide Gates are custom made to fit your opening. There are 2 parts of a cantilever gate. The part which covers the opening, and the back section called the "counter balance," (which is a minimum of 40% of the opening). I.E., a 20' opening has a minimum of an 8' counterbalance.

The track of your Eastern gate and the member of the gate frame are a one piece aluminum extrusion. There are no bolt-on tracks. All other members of the frame are welded to the top member. Unlike some similar gates that bolt together, your Eastern gate will be trouble free for many years.

Because the track is at the top, there are no ground rollers. There are guide rollers on the post that keep the bottom of the gate from swaying.

The top roller assemblies each have 4 factory lubricated and sealed roller bearing wheels that operate inside the track. Because they are inside the track, they are unaffected by ice, snow, dirt, or other debris.



STRENGTH



SECURITY



DURABILITY



DIFFERENT COLORS



ANY SIZE OPENING



ISL - Internal Slide Gate Latch



ISTB - Internal Slide Gate Track Bracket



ISGUIDE - Internal Slide Gate Bottom Guide

INTERNAL SLIDE GATE HARDWARE KITS



INTERNAL SLIDE GATE HARDWARE KITS - SQUARE POST

Item No.	Description	Each
EOESG-KIT	INCLUDED HARDWARE FOR SQUARE POST SINGLE GATE KIT ISGUIDE-S4 (2 each) Internal Slide BTM Guide for 4" Square Post ISL-S4 (1 each) Internal Slide Gate Latch 4" Square Post, ISTB-S4 (2 each) Internal Slide Track Bracket for 4" Square Post ISTA (2 each) Internal Slide Track Assembly (Used Inside Track of Gate)	
EOESGDT-KIT	INCLUDED HARDWARE FOR SQUARE POST DUAL TRACK KIT ISGUIDE-S4 (2 each) Internal Slide BTM Guide for 4" Square Post ISL-S4 (1 each) Internal Slide Gate Latch 4" Square Post, ISTB-S4 (4 each) Internal Slide Track Bracket for 4" Square Post ISTA (4 each) Internal Slide Track Assembly (Used Inside Track of Gate)	

INTERNAL SLIDE GATE HARDWARE KITS - ROUND POST

Item No.	Description	Each
ESG-KIT	INCLUDED HARDWARE FOR ROUND POST SINGLE GATE KIT ISGUIDE-S4 (2 each) Internal Slide BTM Guide for 4" Round Post ISL (1 each) Internal Slide Gate Latch 4" Round Post, ISTB (4 each) Internal Slide Track Bracket for 4" Round Post ISTA (4 each) Internal Slide Track Assembly (Used Inside Track of Gate)	
ESGDT-KIT	INCLUDED HARDWARE FOR ROUND POST SINGLE GATE KIT ISGUIDE-S4 (2 each) Internal Slide BTM Guide for 4" Round Post ISL (1 each) Internal Slide Gate Latch 4" Round Post, ISTB (4 each) Internal Slide Track Bracket for 4" Round Post ISTA (4 each) Internal Slide Track Assembly (Used Inside Track of Gate)	



ISGUIDE - Internal Slide Gate Bottom Guide



ISL - Internal Slide Gate Latch



ISTB - Internal Slide Gate Track Bracket



ISTA - Internal Slide Gate Track Assembly (Used Inside Track of Gate)

INTERNAL SLIDE GATES

CALL FOR QUOTE



FEATURES:

A FRAME FOR EVERY SIZE OPENING

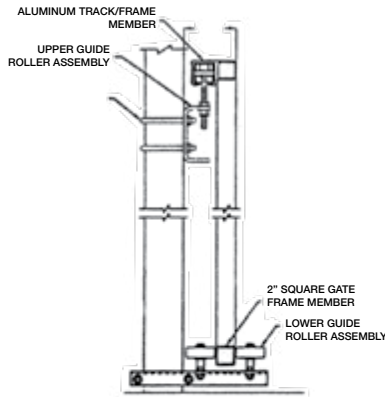

End View
Upper & Lower Guide Roller Assembly Attached to Post

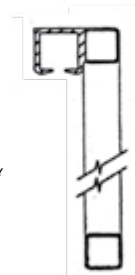

Single Track Single Gate
3'-0" to 22'-0"

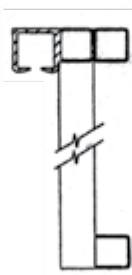

Single Track Single Gate Strengthened
23'-0" to 30'-0"

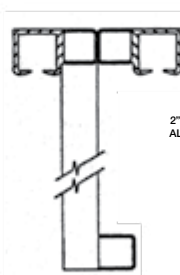

Dual Track Single Gate
31'-0" to 40'-0"

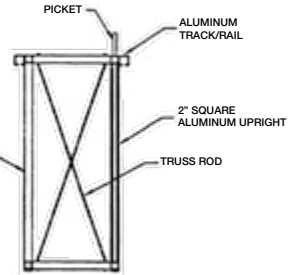

Box Frame
41'-0" to 50'-0"

Gate Elevation - (4) Bays Shown

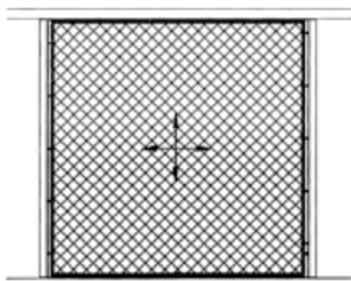
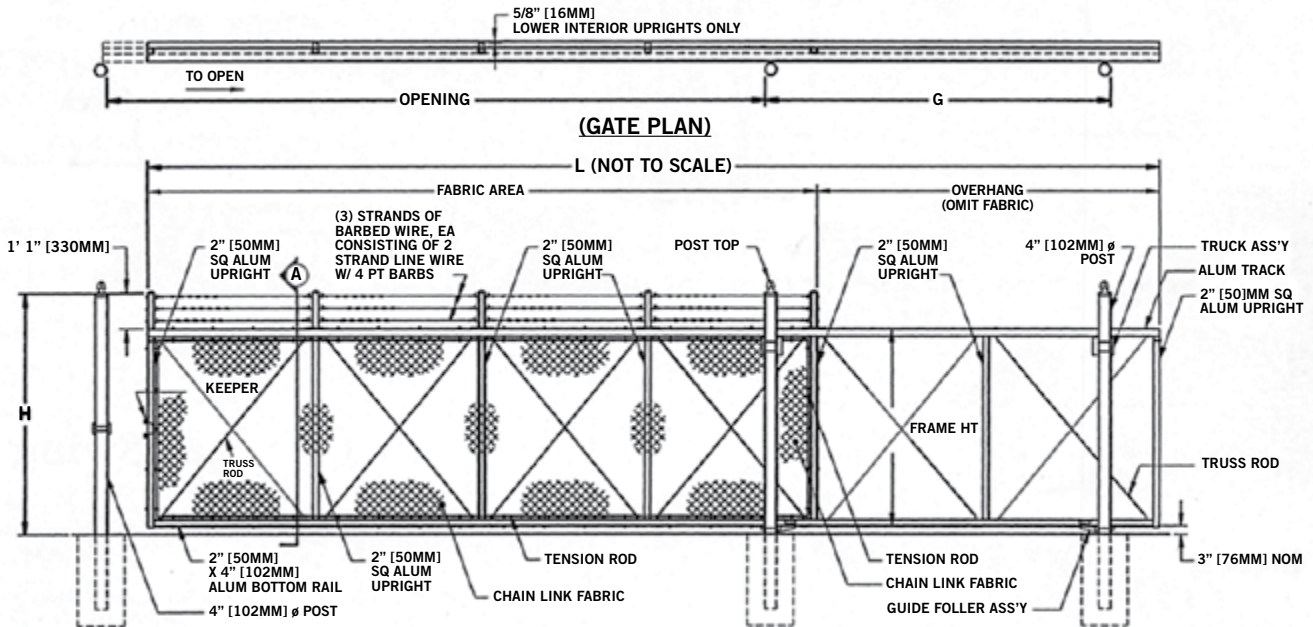

Fabric Stretched 4 Ways to Support the Fence

The "infill" of a Slide Gate helps to support the frame. When a chain link infill is desired, the chain link fabric is stretched 4 ways. This means that each strand of the wire acts as a truss to support the frame. Most manufacturers stretch their fabric in only one direction. In that case, the fabric works against the frame by merely adding weight.

Eastern Internal Slide Gate Specifications:

1. Scope:

This specification covers materials and construction requirements for Eastern Chain Link Cantilever Slide Gates with enclosed track and hardware, up to 8' high.

2. Reference Standards:

ASTM B221 & F1184 TYPE II, CLASS 2

3. General

- A. Gate frame made of 2" square aluminum tubing the alloy and temper to be in accordance with 6063-T6. Tube shall be 0.94 lbs./ft. All members welded into a rigid 1-piece unit. There will be 2 truck assemblies, each having 4 factory lubricated and sealed roller bearing wheels that operate inside the track. A cantilever overhang support panel shall be provided for each leaf of the gate. The overhang shall be a minimum of 40% of the opening.
- B. Chain link fabric shall be installed using hook bolts that are inserted through pre-drilled holes in the frame. To these hook bolts the fabric will be attached by means of a tension bar which is laced through the last link of the fabric. The hook bolts are 15" on center and on all 4 sides of the gate.
- C. Diagonal adjustable 3/8" galvanized truss rods shall be provided inside each panel of the gate. All 8' sections shall have a double rod (one in each direction).
- D. The track and top-rail aluminum extrusion combination weighing 3.72 lbs./ft. shall withstand a 2,000 lb. reaction load.
- E. Truck assembly is a swivel type with a galvanized steel base unit and 4 lubricated sealed ball bearing rollers. Each roller is 2" in diameter and 9/16" in width. The truck shall have 2 side rollers to assure alignment inside the track. Truck assemblies are held to post using a 5/8" galvanized bolt. Truck assembly to withstand a 2,000 lb. reaction load.
- F. Gate post brackets, latch and keepers are galvanized steel.

4. Installation

Gate posts are to be set into concrete (3,000 PSI). The footing shall be 3'0" deep and 16" in diameter. The 4" O.D. posts should be 3'0" (approximately) into concrete footing. Posts must be plumb. Install gates making sure they are free of obstructions. Adjust for smooth operation.

CANTILEVER SLIDE GATES

CALL FOR QUOTE



SIDE VIEW – TYPICAL POST ROLLER

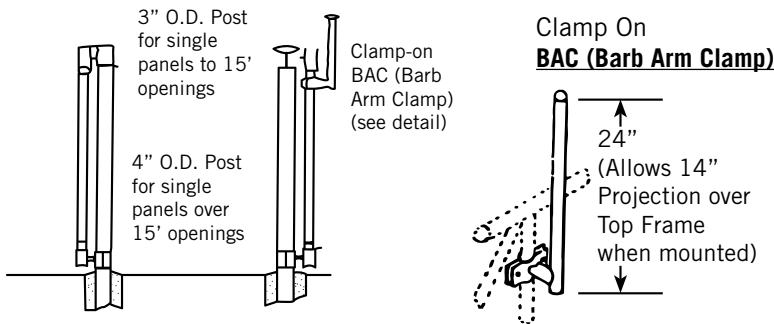

Notes

1. Top/Bottom frame Members to be 2-1/2" O.D.
2. Vertical Frame Members to be 2" O.D.
3. Diagonal/Horizontal Members to be 1-5/8" O.D.
4. Vinyl coating on bracing and vertical members

REAR VIEW - SHOWING BRACE CONSTRUCTION

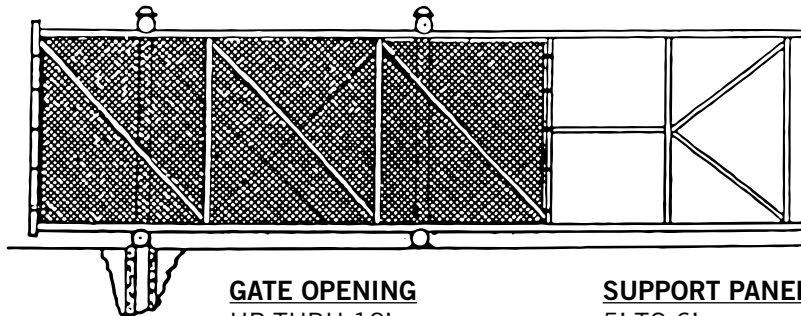

NOMINAL FENCE HEIGHT MINUS 6" (FOR BOTTOM ROLLER CLEARANCE)

Gates 20' and over use nylon rollers.

GATE OPENING

UP THRU 12'
OVER 12' THRU 24'

SUPPORT PANEL LENGTH

5' TO 6'
1/2 OF GATE OPENING

HEIGHT	OPENING LENGTH	PRICE
6'0" - 14'	10' - 30'	CALL FOR QUOTE

NOTE: WHEN OPERATOR IS BEING USED IT IS HIGHLY RECOMMENDED TO INSTALL AN OUTRIGGER – INSTALLED IN FIELD GATES MAY BE OPERATED MANUALLY OR WITH A MOTOR

CANTILEVER SLIDE GATES

CALL FOR QUOTE



BASIC CANTILEVER GATE LAYOUTS

SLIDE LEFT GATE

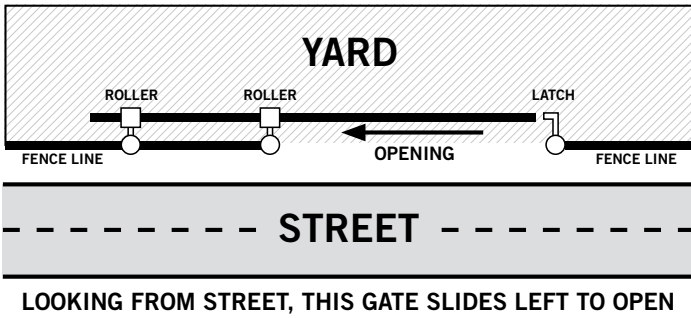

SLIDE RIGHT GATE

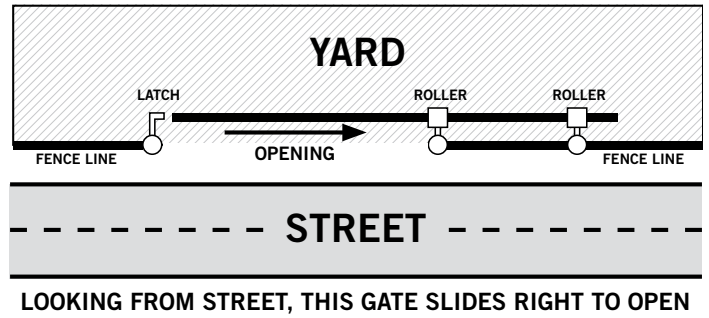

CANTILEVER GATE SAFETY RECOMMENDATIONS

ASTM F1184-93

REQUIRES GUIDE POSTS AND ROLLER GUARDS ON EXTERNAL ROLLER CANTILEVER SLIDE GATES

MUST ORDER WITH EACH ROLLER



CRGUARD
TOP ROLLER GUARD

Vertical post placed on both sides of the exposed rollers can prevent hands from reaching these pinch points. Safety edges placed on these posts can be wired to stop the unit upon contact.

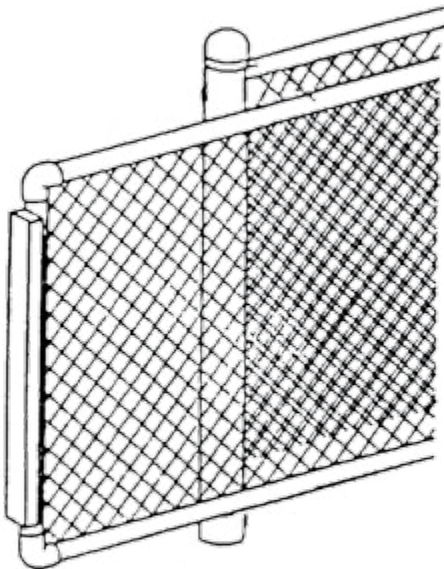

INTERNAL SLIDE GATES

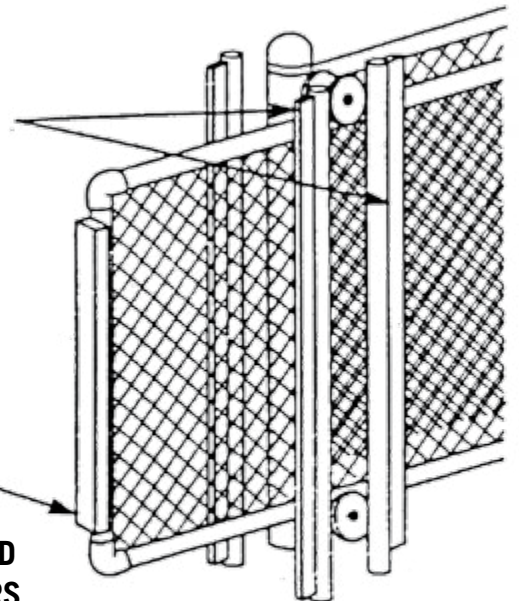

EXTERNAL SLIDE GATES

**SAFETY EDGES ARE RECOMMENDED
WHEN USED WITH GATE OPERATORS**

CALL FOR QUOTE

ROLLING GATE FRAMES

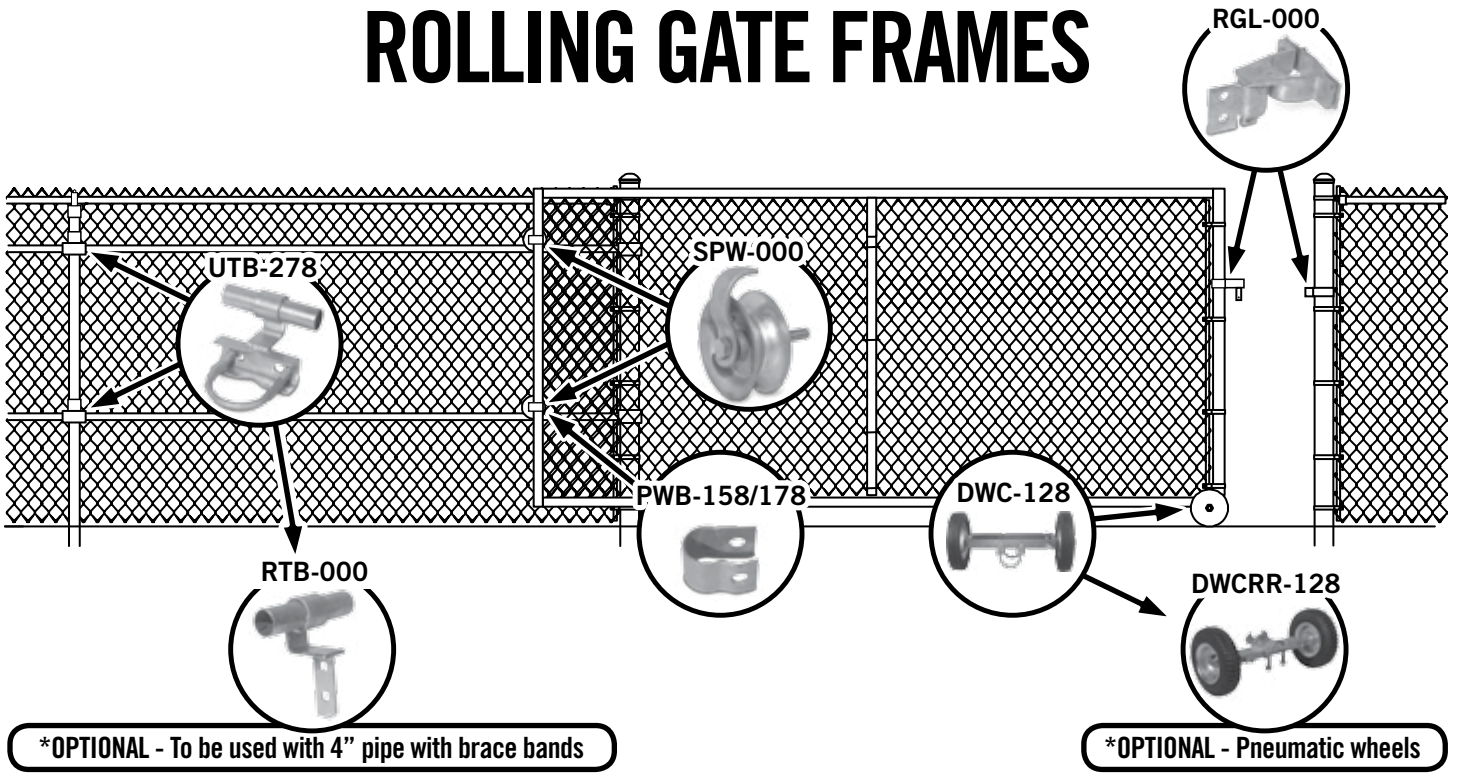

FRAME CONFIGURATION - OPENING SIZES

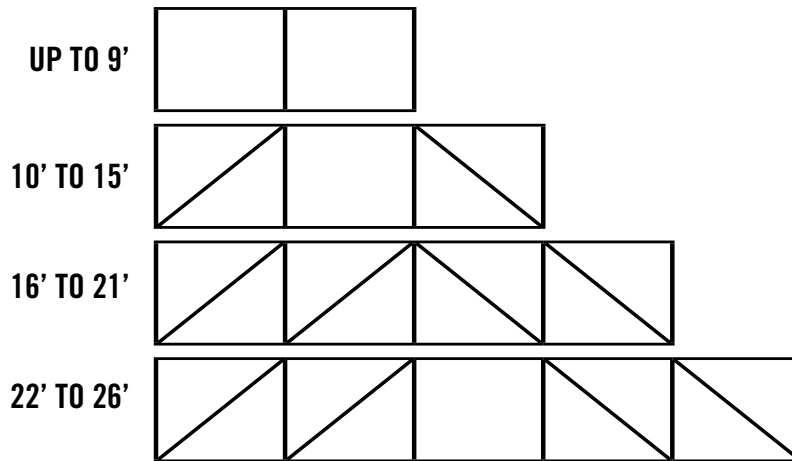

NOTES:

1. MADE WITH 1-5/8" SS20 PIPE AND 1-3/8" RES BRACING
2. GATES ALSO AVAILABLE IN HEAVIER PIPE.
3. GATES AVAILABLE OVER 26' LENGTH
4. ROLLING GATE HARDWARE – SEE PAGE C14 & C15

GATES PRICES — CALL FOR QUOTE

ACCORDION (BI-FOLD) GATES

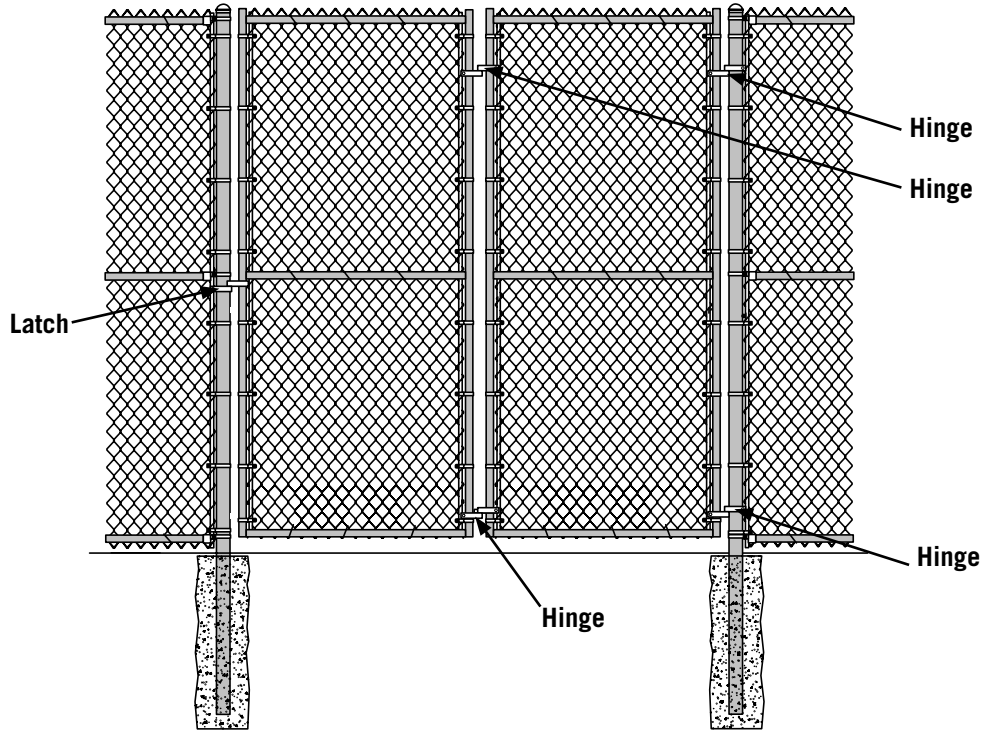

PIPE BENDING

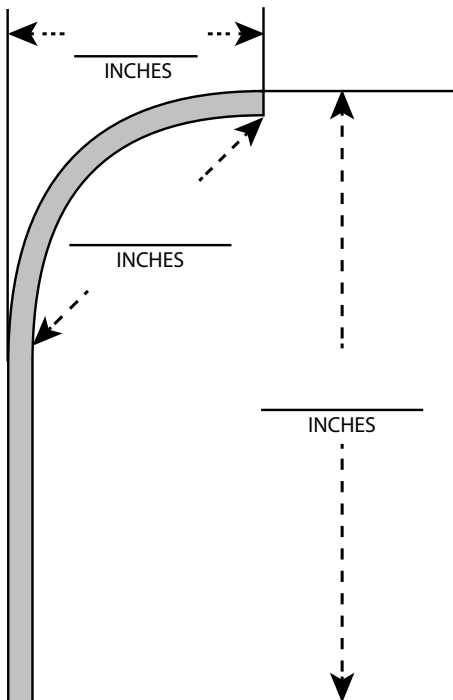

MUST GIVE MEASUREMENTS FOR ACCURATE BENDING

WELDED FLANGES

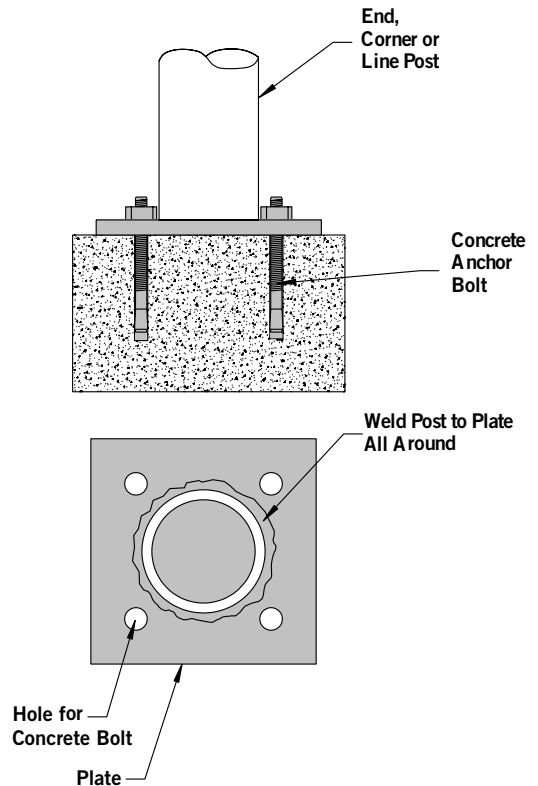

DECORATIVE SLATS and HEDGE



“VPS” DECORATIVE SLATS

"VPS" Decorative Slats are made from high density virgin polyethylene with special ultra-violet inhibitors to insure longer life. Regular Slats are flat and tubular in shape and pre-notched for insertion of horizontal retainer. “VPS” slats carry a full 10 year warranty against fading and breakage. Regular slats have approx. 80% coverage and winged slats approx. 95% coverage.

FOR 2" MESH (Others Available)

“VPS” DECORATIVE SLATS - WINGED

Item#	Description	Fence Height	Slats/Bag	Feet/Bag	Loose
BTP3-	VPS Decorative Winged Slat	3'	85	10'	
BTP42-	VPS Decorative Winged Slat	3-1/2"	85	10'	
BTP4-	VPS Decorative Winged Slat	4'	85	10'	
BTP5-	VPS Decorative Winged Slat	5'	85	10'	
BTP6-	VPS Decorative Winged Slat	6'	85	10'	
BTP7-	VPS Decorative Winged Slat	7'	85	10'	
BTP8-	VPS Decorative Winged Slat	8'	85	10'	

“VPS” DECORATIVE SLATS - REGULAR

Item#	Description	Fence Height	Slats/Bag	Feet/Bag	Loose
BP3-	VPS Decorative Regular Slat	3'	85	10'	
BP42-	VPS Decorative Regular Slat	3-1/2"	85	10'	
BP4-	VPS Decorative Regular Slat	4'	85	10'	
BP5-	VPS Decorative Regular Slat	5'	85	10'	
BP6-	VPS Decorative Regular Slat	6'	85	10'	
BP7-	VPS Decorative Regular Slat	7'	85	10'	
BP8-	VPS Decorative Regular Slat	8'	85	10'	
BP10-	VPS Decorative Regular Slat	10'	85	10'	
BP12-	VPS Decorative Regular Slat	12'	85	10'	

COLORS AVAILABLE: DESERT SAND (DS), EASTERN GREEN (EG), WHITE (WT), BROWN (BR), BLACK (BK), REDWOOD (RD) AND GRAY (GY)
MANY OTHER COLORS ALSO AVAILABLE.



Eastern HEDGE



Eastern Hedge creates a natural hedge look on chain link fence, which requires no maintenance, water, or trimming. Eastern Hedge requires no locking device or tools. It installs much like our classic bottom-locking or top-locking slats.

“VPS” DECORATIVE SLATS - HEDGE

Item#	Description	Fence Height	Branches Per Bag	Feet/Bag	Boxes Per Pallet	Each Per Box	Pallet Per Box	4 Pallets Per Box
EH4	EASTERN HEDGE	4'	82	10'	25			
EH5	EASTERN HEDGE	5'	82	10'	25			
EH6	EASTERN HEDGE	6'	82	10'	25			
EH8	EASTERN HEDGE	8'	82	10'	25			
EH10	EASTERN HEDGE	10'	82	10'	25			
EH12	EASTERN HEDGE	12'	82	10'	25			

Eastern Wood & Steel Guard Rail

Did you know that Eastern Fence is also one of the largest suppliers of Guard Rail?

Eastern Fence carries a terrific supply of wood and steel guard rail products for your safety needs. **Guard rail** or **guardrail**, sometimes referred to as **guide rail**, is a system designed to keep people or vehicles from (in most cases unintentionally) straying into dangerous or off-limits areas.

WOOD GUIDE RAIL

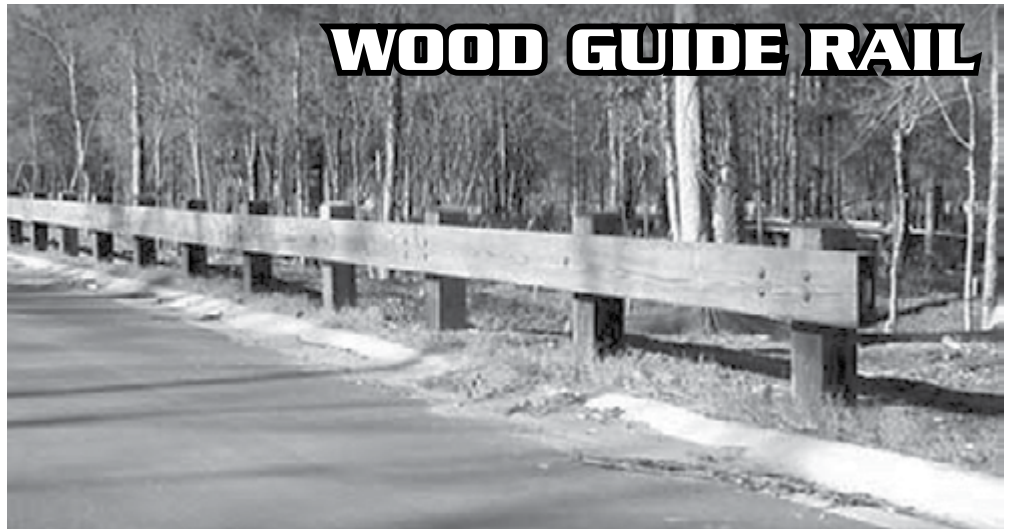
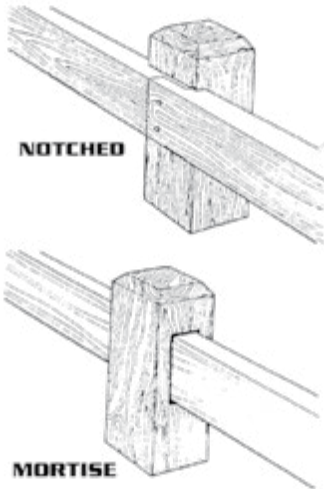

Guardrails are used in a facility setting to protect a company's greatest assets which include their people and expensive equipment.

In traffic engineering, highway guardrail may prevent an errant vehicle from impacting roadside obstacles which may be either man-made (sign structures, culvert inlets, utility poles) or natural (trees, rock croppings), running off the road and going down a steep embankment, or veering off the roadway into oncoming traffic.

GUARD RAIL

"W" Beam Guardrail

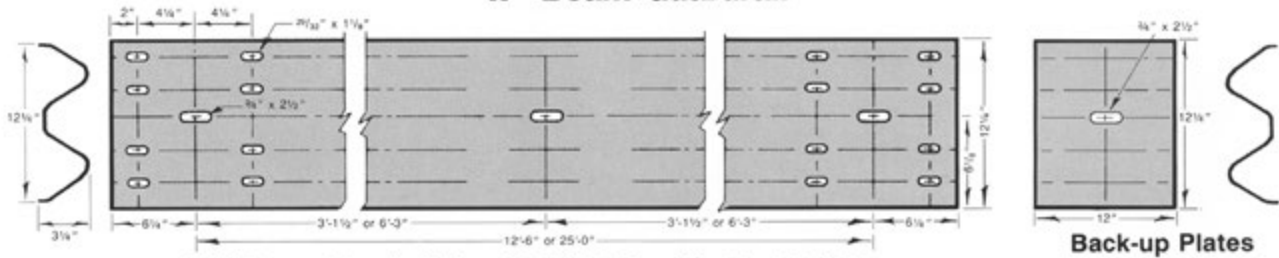

"W"-Beam Guardrail Per AASHTO Specification M-180

Class A — 12 gauge (.105 nom.)
Class B — 10 gauge (.135 nom.)

Types
Type 2 — Zinc Coated 3.6 oz./sq. ft.
Type 3 — Unfinished Beam (to be painted)
Type 4 — Corrosion Resistant Steel (weathering)
Standard Lengths are 12'6" and 25'0"
(Special lengths available upon request)

Posts and Blocks



4" x 6" x 8.5# or 9#
Any length posts
(heavier structural shapes available)



3" x 5.7# x 5'3"
Standard Beams
with or without
welded deflection plate
(8" x 24")

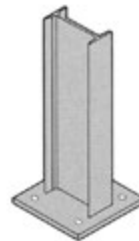

Post on Plate
all sizes structural
various plate sizes
any length

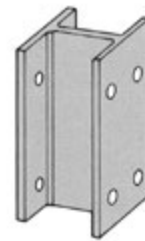

4" x 6" x 8.5# or 9#
13" or 14" Standard
any length available

Available Hot Dip Galvanized or Corrosion Resistant Steel

Galvanized Hardware

(Some items available in corrosion resistant steel)

Button Head Bolt and Recessed Nut

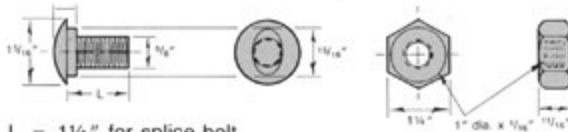

L = 1 1/4" for splice bolt
L = 2" for steel post bolt
L = 4 1/2" for rub rail post bolt
L = 10", 16", or 18" For wood or concrete post bolt

Washers Square

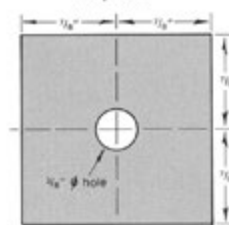

Hook Bolts

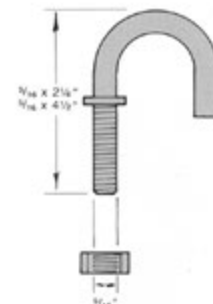

Hex Head Bolt and Nut



5/16 dia. x 1 3/4" long post bolt
1/2 dia. x 1 1/2" long support bolt
5/8 dia. x 1 1/2" long block bolt
3/4 dia. x 1 1/2" long block bolt
3/4 dia. x 18" long anchor bolt
7/8 dia. x 18" long anchor bolt

Rectangular

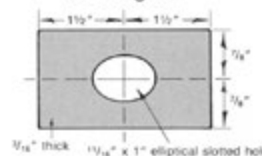

Round



GUARD RAIL

Terminal Sections

Galvanized or corrosion resistant steel

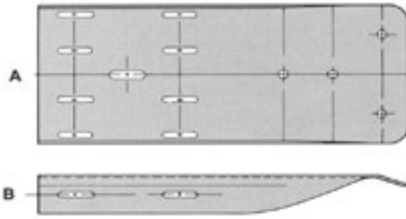

A — End Shoe, flat
B — End Shoe, bent lip (for BCT)

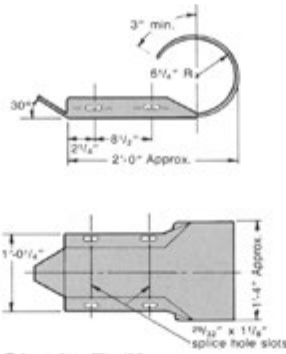

Single Buffer

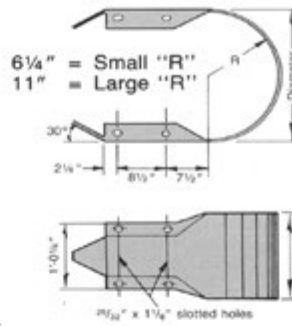

Double Buffer



Flared End

Curved Guardrail

Your protection is our business. We help protect life, equipment and property with the application of our guard rail barrier — your "safety belt" on the modern highway. This "profile of protection" is designed to help eliminate injury, death and property damage due to natural hazards along our highways.

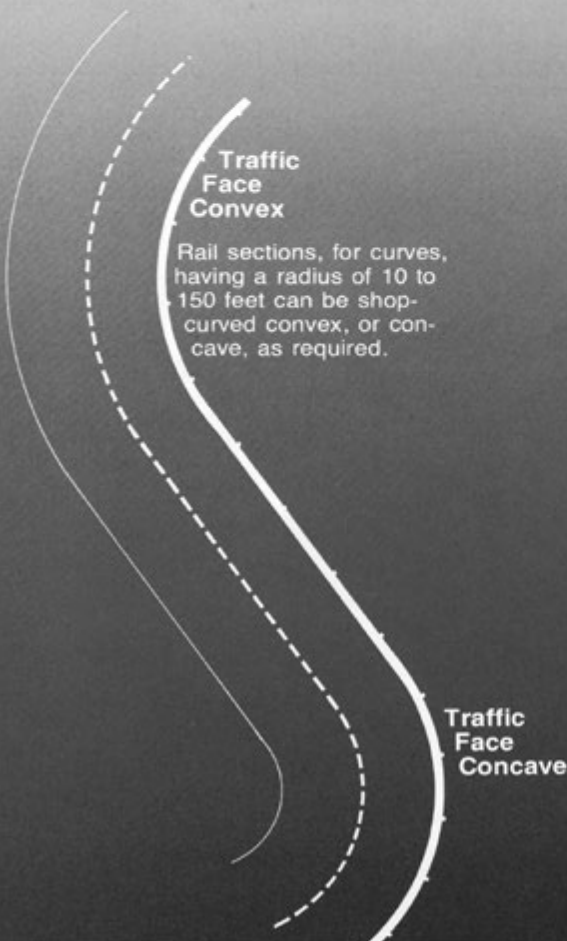
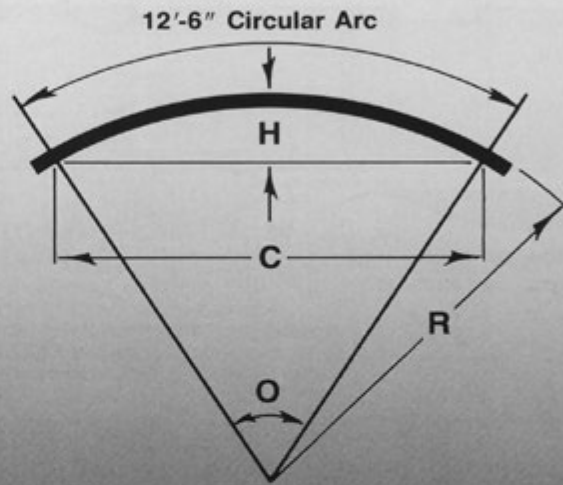

Functions of 12'-6" Circular Arc

Radius (R)	Central Angle (O)	Chord (C)	Rise (H)
10	71°-37'	11'-9"	1'-10 ³ / ₈ "
15	47°-45'	12'-1 ³ / ₄ "	1'-3 ¹ / ₂ "
20	35°-49'	12'-3 ⁵ / ₈ "	11 ⁵ / ₈ "
25	28°-39'	12'-4 ¹ / ₂ "	9 ¹ / ₂ "
30	23°-52'	12'-4 ⁷ / ₈ "	7 ³ / ₄ "
35	20°-28'	12'-5"	6 ³ / ₄ "
40	17°-54'	12'-5 ¹ / ₄ "	6"
45	15°-55'	12'-5 ¹ / ₂ "	5 ¹ / ₄ "
50	14°-19'	12'-5 ⁵ / ₈ "	4 ⁵ / ₈ "
55	13°-01'	12'-5 ⁵ / ₈ "	4 ¹ / ₄ "
60	11°-56'	12'-5 ³ / ₄ "	4"
65	11°-01'	12'-5 ³ / ₄ "	3 ⁵ / ₈ "
70	10°-14'	12'-5 ³ / ₄ "	3 ³ / ₈ "
75	9°-33'	12'-5 ³ / ₄ "	3 ¹ / ₄ "
80	8°-57'	12'-5 ³ / ₄ "	3"
85	8°-26'	12'-5 ⁷ / ₈ "	2 ³ / ₄ "
90	7°-57'	12'-5 ⁷ / ₈ "	2 ⁵ / ₈ "
95	7°-32'	12'-5 ⁷ / ₈ "	2 ¹ / ₂ "
100	7°-10'	12'-5 ⁷ / ₈ "	2 ³ / ₈ "
110	6°-31'	12'-5 ⁷ / ₈ "	2 ¹ / ₈ "
120	5°-58'	12'-6"	2"
130	5°-31'	12'-6"	1 ³ / ₄ "
140	5°-07'	12'-6"	1 ⁵ / ₈ "
150	4°-46'	12'-6"	1 ¹ / ₂ "

GUIDE/BARRIER RAIL - STEEL

GUIDE/BARRIER RAIL - STEEL HIGHWAY RIBBON STYLE - GALVANIZED

Rails, available in either 10 gauge or 12 gauge thickness, are 13' 6" long. Due to rail overlap, the erected section length will be 12'-6". Posts are available 5'-9" long and are pre-punched to accept offset blocks and/or all standard rails.

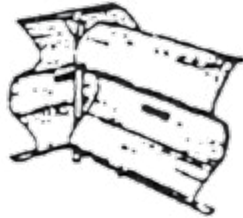

INSIDE CORNER

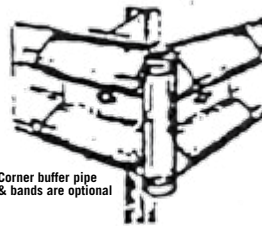

Corner buffer pipe & bands are optional

OUTSIDE CORNER

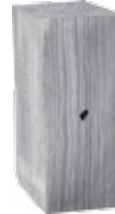

BLK13

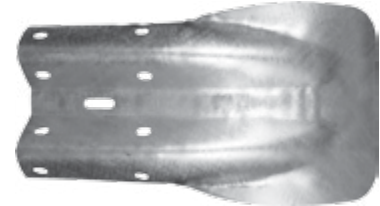

FLR



RAIL

(BOX BEAM AVAILABLE)

Chart for Hardware for Guardrail:

- Rail = 8 Short Bolts, 8 Nuts
- Flairs = 4 Short Bolts, 4 Nuts
- Single Wraps = 4 Short Bolts, 4 Nuts
- Double Wraps = 8 Short Bolts, 8 Nuts
- Posts = 1 Long Bolt, 1 Nut, 1 Washer

GUIDE/BARRIER RAIL - STEEL

Item#	Description	Loose
GR12	12-Gauge Galvanized Guide Rail	
GR10	10-Gauge Galvanized Guard Rail (Special Order)	
GRP59	Guard Rail Post, 4"x 6"x 8.5#/Ft. x 5'6"	
SWA	Guard Rail Single Wrap Around	
FLR	Guard Rail Flair End	
DWA	Guard Rail Double Wrap Around	
CCI	Guard Rail Corner Connector (Inside)	
CCO	Guard Rail Corner Connector (Outside)	
BLK13	Guard Rail Offset Block 13"	
BUP	Guard Rail Back Up Plate	
GRL	Guard Rail Long Bolt 5/8" x 2"	
GRS	Guard Rail Short Bolt 5/8" x 1-1/4"	
GRW	Guard Rail Washer	
GRN	Guard Rail Double Recess Nut 5/8"	
GRB10	5/8" x 10" Guard Rail Block Bolt	

GUIDE/BARRIER RAIL - WOOD



GUIDE/BARRIER RAIL - WOOD

8 x 8 x 5' 4" Southern Yellow Pine

MORTISE or NOTCH Styles .40 CCA Treated
For maximum effectiveness all milling is done prior to treatment.

30 YEAR GUARANTEE

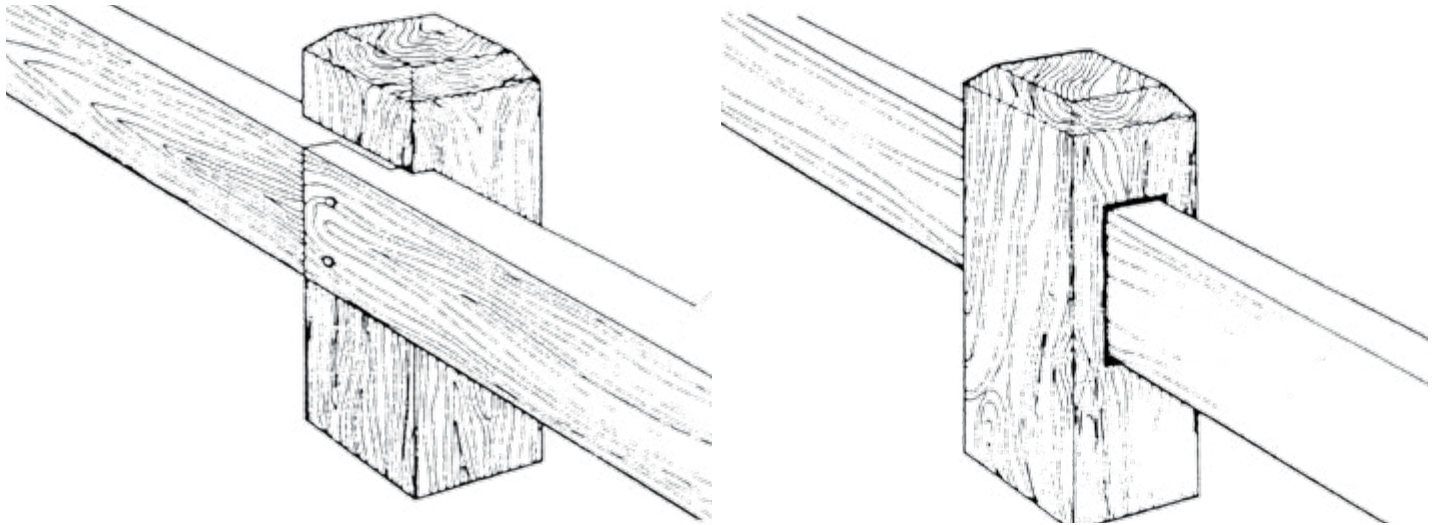

GUIDE/BARRIER RAIL - WOOD

Item#	Description	Loose
WGRN	Wood Guide Rail Notched Post	
WGRML	Wood Guide Rail Mortise Line Post	
WGRME	Wood Guide Rail Mortise End Post	
WGRMC	Wood Guide Rail Mortise Corner Post	
WGRR	Wood Guide Rail 4 x 8 x 10 Rail	
WGRLAG	Wood Guide Rail 1/2" x 6" Lag Bolt	

**FOR OTHER STYLES
CALL FOR PRICE AND AVAILABILITY**

CHAIN-LINK & SPECIALTY FENCE PRODUCTS



The Next Generation of Fence!

www.easternchainlinkfence.com

Eastern
**CHAIN LINK
FENCE**

SPECIALIZED FENCE

SNOW FENCE

50' PER ROLL - SLAT SIZE 3/8" x 1-1/2" SPACED 2-1/2" APART - 5 STRAND

Item #	Description	Height	Each	20+ Rolls
SF48	48" Snow Fence	48"		
SF48-NATURAL	48" Natural Snow Fence	48"		



ORANGE SAFETY FENCE

SSC-100 --- 4 x 100

Item #	Mesh Size	Roll Size	Colors	Per Roll	20+ Rolls
SSC-100	3" x 1.5"	4 x 100 ft.	ORANGE		



FARM AND FIELD FENCE

Item #	Style	Length (Feet)	Each	20+ Rolls
FF10470612	1047-06-12½-Gauge 47" Height	330'		
FF2096612	2096-6-12½-Gauge 96" Height	330'		
FF2096612-BK	2096-6-12½-Gauge 96" Height	330'		

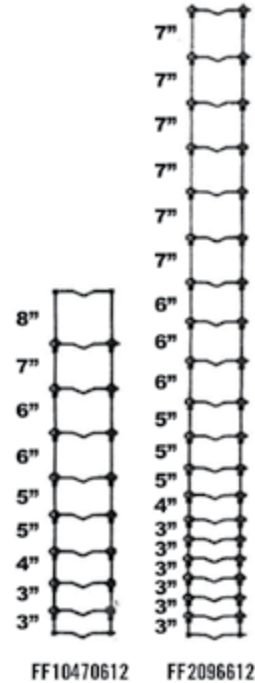

STUDED T-POST

50,000 PSI with anchor plate | 5 T-Fasteners are furnished with each

Item #	Description	Size	Each	20+ Rolls
STP72	Studded "T" Post	6'		

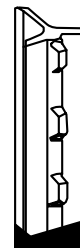

SPECIALIZED FENCE



VINYL COATED WELDED FENCE 2" x 3" MESH - 50 FT. ROLLS

(YARD GUARD)

Item #	Height	Color	Approx Pounds	Price Per Roll	20+ Rolls
YG36-	36"	Black (BK) or Eastern Green (EG)	21		
YG48-	48"	Black (BK) or Eastern Green (EG)	27		

HEAVY DUTY VINYL COATED WELDED FENCE 4" x 2" MESH - 50 FT. ROLLS

Item #	Height	Color	Approx Pounds	Price Per Roll	20+ Rolls
HDYG36-	36"	Black (BK) or Eastern Green (EG)	28		
HDYG48-	48"	Black (BK) or Eastern Green (EG)	37		
HDYG60-	60"	Black (BK) or Eastern Green (EG)	47		
HDYG72-	72"	Black (BK) or Eastern Green (EG)	56		

POOL FENCE 1" x 1" MESH - 50 FT. ROLLS

Item #	Description	1-19 Rolls	20-39 Rolls	40+ Rolls
POOL48-	48" x 1" x 1" x 50' x 16-Gauge Vinyl Welded Mesh			
POOL72-	72" x 1" x 1" x 50' x 16-Gauge Vinyl Welded Mesh			

HEAVY DUTY U-POSTS 13 GAUGE - 5 POSTS PER BUNDLE

Item #	Length	Color	Price Each	Master Bundle 200 Each
HDP72-	72"	Black (BK) or Eastern Green (EG)		
HDP96-	96"	Black (BK) or Eastern Green (EG)		

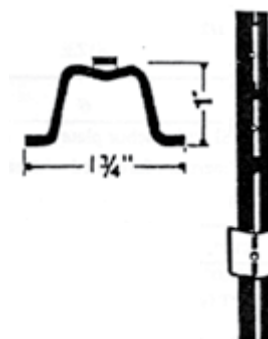

STAPLES GALVANIZED

Item #	Description	Price Each
STAPLES-5	1-1/2" x 9-Gauge Staples Case 5 Lbs.	
STAPLES	1-1/2" x 9-Gauge Staples Case 50 Lbs.	



DEER FENCE

DEER8 (TENAX C-FLEX)

Once installed, DEER8 / DEER8-100 are virtually invisible against your landscaping. The fence are recommended for areas which experience light to moderate deer traffic. Popular with both landscapers and professional installers, DEER8 / DEER8-100 can be used to enclose the perimeter of your property or smaller areas such as gardens.



Item #	Roll Dimensions	Mesh Size	Rolls Per Pallet	Each	20+
DEER8	7.5' High - 330' Per Roll	1.77" x 1.97"	20		
DEER8-100	7.5' High - 100' Per Roll	1.77" x 1.97"	20		

DEER8HD (TENAX C-FLEX P)

The "HD" stands for premium strength. Like DEER8, DEER8HD is virtually invisible once installed and is recommended for areas that experience heavy deer traffic.

Item #	Roll Dimensions	Mesh Size	Rolls Per Pallet	Each	20+
DEER8HD	7.5' High - 164' Roll	1.77" x 1.97"	25		

DEER8XH (TENAX C-FLEX HEAVY)

DEER8XH is the heaviest grade product, ideal for professional installers in areas with large deer traffic.

Item #	Roll Dimensions	Mesh Size	Rolls Per Pallet	Each	20+
DEER8XH	7.5' High - 100' Roll	1.77" x 1.97"	25		

WOVEN WILDLIFE FENCE

Woven Steel - Hot Dip Galvanized - or Black | Graduated Sizes 6" Wide Spacing - Class 3
6 Lines of 3" - 2 Lines of 4" - 2 Lines of 5" | 3 Lines of 6" - 6 Lines of 7"

Item #	Height	Roll Size	Rolls Per Pallet	Per Roll
FF2096612	7.5' High	330' Per Roll	6	
FF2096612-BK	7.5' High	330' Per Roll	6	

INSTALLATION

- Tubular 1 3/8" pipe rail steel, pressure treated 2" x 4"s or 4" x 4"s, or metal poles should be used and spaced no more than 15' apart. For optimum results, use 10 foot posts which should be buried 3 feet deep. When trees are in installation path, wrap the netting around the tree and pull the fence tight before securing to supports. For additional support, weave a tension wire along the top and bottom of the fence to secure it to the supports.

- Deer are notorious for trying to push under fence! In order to keep them from getting in, be sure the fence netting touches the ground so that you can anchor it using 12" to 18" metal stakes every 8' - 10', or by attaching a running length of wire end to end, securely fastening it to the bottom of the fence. Additional reinforcement of a metal fence or chicken wire may be added to bottom for protection against rabbits and other animals that tend to chew through the fence.

- You will need to attach 12" long white ribbon onto the fence every 10' at a height of 4'. This will allow the deer to see the newly installed barrier, and keep them from running into it. The ribbon should be left up for six to eight weeks. It is most important to place ribbon along areas of high deer traffic and/or time worn paths (we also recommend using a double layer where frequently traveled paths exist).

- Corner posts may need additional support by using braces or support wires to hold them steady.

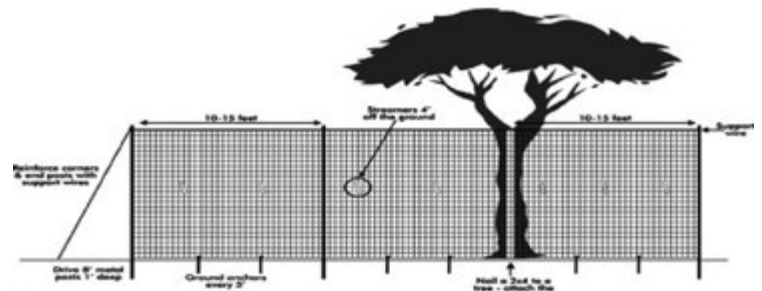

STEEL HEX WEB DEER FENCE

Eastern
CHAIN LINK
FENCE

Black Galvanized Steel, PVC Coated | 35 lb tensile strength per strand
1" Mesh | Virtually Invisible from Approx. 20'

Item #	Height	Roll Size	Roll Weight	1-4 Rolls	5 Rolls or More
DEERHEX-100-BK	7.5' High - 100' Per Roll	7.5'H x 100'L	80 lbs.		

INSTALLATION

Steel Hex Web Deer Fence is recommended for those experiencing high deer pressure and want a secure, chew-proof barrier for a garden, residential property, or commercial land. This steel fence can also serve as a fence for dogs that like to chew and dig. Built to last, this fence combines aesthetically pleasing hexagonal openings with a UV-resistant powder-coating to protect the steel wire from harsh weather conditions. Combining this fencing with a monofilament tension line makes a stable, strong barrier against deer and rodents including rabbits, squirrels, and gophers.

What makes Steel Hex Web Fencing THE right choice?

- Chew-Resistant
- 1" openings keep all but the smallest pests away
- 20 - 30 yr. life span
- Nearly invisible after 20'

Steel Hex Web Deer Fence is simple enough for anyone to install without the help of a professional. This fence is an incredibly lightweight, yet durable alternative to more costly and complicated fence systems. Installation with our no-dig ground sleeve post system and UV treated heavy duty ties is simple enough for anyone. Once installed, this deer fence will require little to no maintenance.

The UV-resistant coating makes this fencing material incredibly durable and will remain tough even after years of harsh weather. The powder coated black color makes this fence virtually invisible from as close as 20 feet.

Roll Size: 7.5' H x 100' L

Gauge: 20

Life Expectancy: 20-30 years

Mesh Dimensions: 1"

Color: Black

Visibility: Virtually Invisible From Approximately 20'

Material: Galvanized Steel, PVC Coated

Weight: 80 lbs.

Per Strand: 35 lb tensile strength per strand

Dog Fencing: Can serve as a fence for dogs that chew and dig

NEW ITEM!

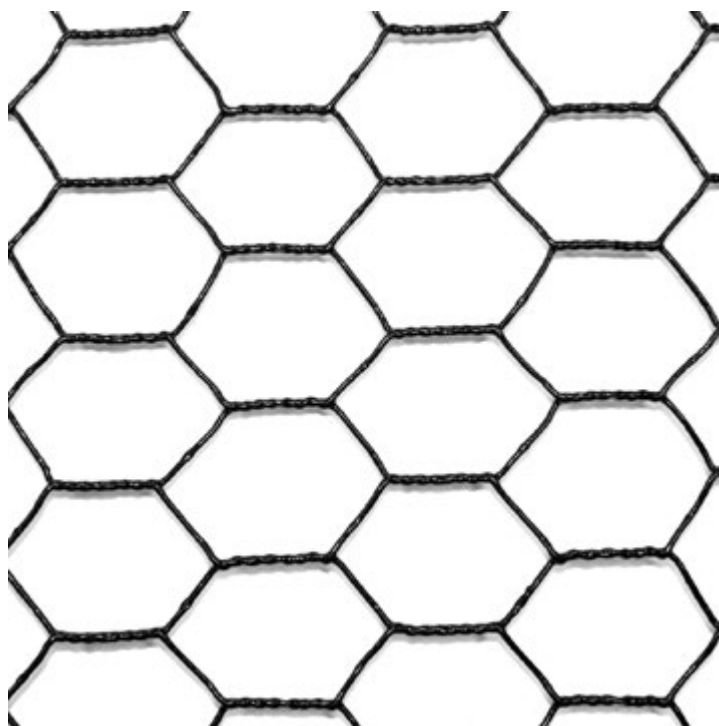

12' x 6' Temp Fence Panels NOW IN STOCK!

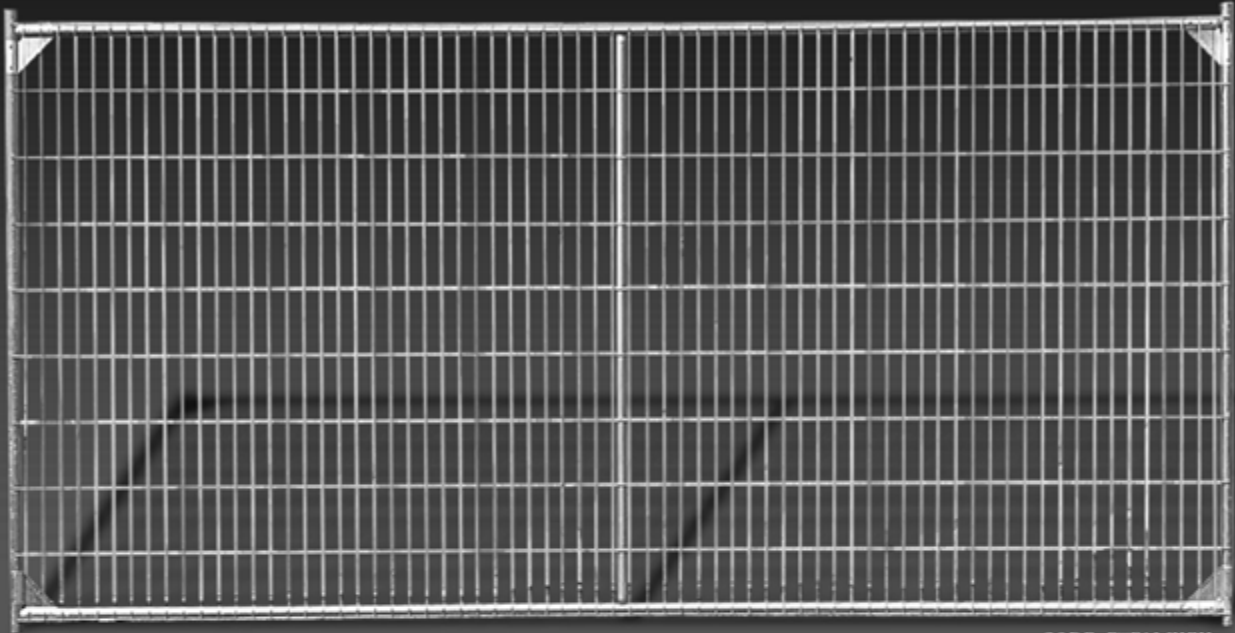

CODE: ETF126WW



- 1/8" Wire Mesh with Clean Lines
- "No-Tangle" Welded Wire Filling
- Gusseted Corners for Long Life
- Ease of Set-Up and Take-Down



CODE:
ETFSC



CODE:
SC138

Closed stands and saddle clamps are always in stock to complete your temporary enclosure needs

The Next Generation of Temp Fence!

www.easternchainlinkfence.com



Eastern
CHAIN LINK
FENCE

EASTERN 12x6 TEMP FENCE 0822 | ©2022 EASTERN WHOLESALE FENCE LLC | ALL RIGHTS RESERVED

TEMP FENCE



Eastern
CHAIN LINK
FENCE

PANELS

6'H Welded Wire Temporary Fence Panels

Item #	Description	Bundle Count	Loose	Bundle	8-Bundle	Truckload
ETF126WW	12'W X 6'H Temp. Fence Panel Welded Wire	12				
ETF128WW	12'W X 8'H Temp. Fence Panel Welded Wire	12				

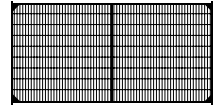

6'H Temporary Fence Panels

Item #	Description	Bundle Count	Loose	Bundle	8-Bundle	Truckload
ETF106	10'W x 6'H Temp. Fence Panel 2-3/8" x 12.5 Ga. Galv. Wire	12				
ETF126	12'W x 6'H Temp. Fence Panel 2-3/8" x 12.5 Ga. Galv. Wire	12				

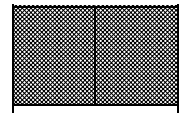

8'H Temporary Fence Panels

Item #	Description	Bundle Count	Loose	Bundle	8-Bundle	Truckload
ETF108	10'W x 8'H Temp. Fence Panel 2-3/8" x 12.5 Ga. Galv. Wire	12				
ETF128	12'W x 8'H Temp. Fence Panel 2-3/8" x 12.5 Ga. Galv. Wire	12				

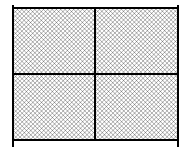

ACCESSORIES

Eastern Temp Fence Stands

Item #	Description	Bundle Count	Loose	Bundle
ETFSC	Eastern Temp. Fence Stand (Closed)	24		



Saddle Clamps

Item #	Description	Case Qty.	Each	Case Each
SC138	1-3/8" x 1-3/8"	125		



Carriage Bolts

Item #	Description	Case Qty.	Per Box of 100	Case QTY Per 100 Box Ea.
NB5125	1-3/8" x 1-3/8"	20		



PRIVACY SCREENS



EASTERN PRIVACY SCREENS - 90% Green or Black

TYPICAL PROPERTIES - Fabric Material High Density Polyethylene Weave Knitted ravel resistant raschel Color Green Weight oz./sq. 4.0 Width 5'8" & 7'8" Water Flow Rate N.A. Tape edges 2-3/4" Woven Polypropylene Black Sewing Thread Monofilament Black Polyethylene Grommets #2 Brass spread grommets. The above PROPERTIES are typical averages. Eastern Privacy Screen is made of UV resistant, high density polyethylene. The yarns are a knitted design the helps reduces ripping, tearing, and fraying.

PRIVACY SCREENS

Item #	Description	Case Count	Loose	Case
EPS906G-BK or EG	Eastern Privacy Screen 90% for 6'H x 100'L with Grommets (18" on ctr.) (Avail. in BK or EG)	12		
EPS908G-BK or EG	Eastern Privacy Screen 90% for 8'H x 100'L with Grommets (18" on ctr.) (Avail. in BK or EG)	12		

GROMMET TIES

Item #	Description	Bndl. Count	Loose	Bundle
EPSGTT	Eastern Privacy Screen Grommet Tie Top (100 ties per bag. 1 bag needed per 100' roll)	24		
EPSGTB	Eastern Privacy Screen Grommet Tie Bottom (100 ties per bag. 1 bag needed per 100' roll)	24		

EASTERN PRIVACY SCREEN

RECOMMENDED FOR USE WITH EASTERN TEMP FENCE

Eastern Privacy Screen is an economical, tape knit that is UV stabilized. Due to it's unique design, it can be installed with or without tape and grommets. It also has a low shrinkage factor and high dimensional stability.

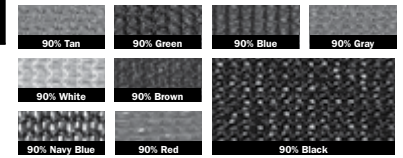

EPS - WOVEN

DESIGNED TO BLOCK SIGHT, WIND, AND STAND UP TO THE ELEMENTS.

Our screens have superior UV resistance for extended life-span and are some of the most rugged outdoor fabrics in the world.

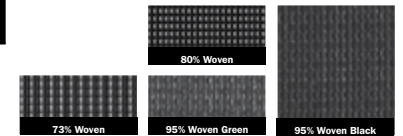

EPS - LATH SHADE

WELL SUITED FOR WINDY APPLICATIONS SUCH AS PRIVACY FENCING OR TENNIS WINDSCREEN.

Eastern Privacy Screen Lath Shade is high UV stabilized, strong, long-lasting, and resistant to abrasion. The airflow openings help to reduce stress on structures.

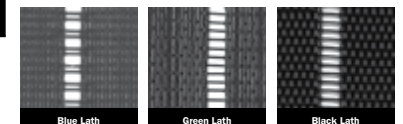

EPS - KNIT WIND SCREEN - (HDPE)

RECOMMENDED FOR USE WITH SPORTS FACILITIES

Great for tennis courts, baseball fields other sports applications. They are made of UV resistant, high density polyethylene. The yarns give the fabric strength and flexibility, and the knitted design ensures against ripping, tearing, and fraying.

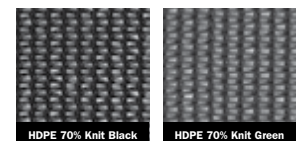

EPS - SOLID PRIVACY VINYL

GREAT FOR SENSITIVE WORK AREAS, HIGH SECURITY INSTALLATIONS.

Coated on both sides and gives a 100% visual block. Fire resistant screens also available.



EPS - KNOTTED NET

FOR USE WITH GOLF COURSES, DRIVING RANGES, BATTING CAGES, AND MORE.

Available with many different opening sizes and yarn thickness for different sports and levels of play. Most nets can be bordered with rope or tape and grommets for easy installation.



"Just Built Better..."



Eastern
**CHAIN LINK
FENCE**

Phone: 800.339.3362 | www.EasternChainlinkFence.com

©Eastern Wholesale Fence LLC • All Rights Reserved